

Owner's Manual



WaterFurnace
Smarter from the Ground Up™



Congratulations on your WaterFurnace purchase!

Thank you for purchasing a WaterFurnace geothermal heating and cooling system. You have joined hundreds of thousands of smart homeowners all over the world who have discovered that geothermal systems are the ultimate heating and cooling technology, providing the best combination of comfort, efficiency, reliability, and safe, clean, quiet operation. That's why our systems are recognized as being "Smarter From The Ground Up". We're confident that your investment in the system will bring you many years of exceptional performance, comfort and savings.

For a quick reference, write your WaterFurnace Dealer's name, telephone number and other important information below:

Company Name: _____

Telephone Number: _____ Emergency: _____

Date of Installation: _____ Warranty: _____

Unit Model Number: _____ Serial Number: _____

Type of Loop System (see page 12).

Check one:

- Horizontal Closed Loop (Type _____, # Trenches/Bores _____, Trench Length _____, Depth _____)
- Vertical Closed Loop (# Boreholes _____, Depth of Boreholes _____)
- Pond Loop (# Coils _____, Ft. of Pipe _____, Pond Depth _____)
- Open Loop / Well Water (Gallons per minute _____, Discharged to _____)
- Loop Antifreeze (Type: _____)

MAJOR OPTIONS INSTALLED (CHECK ALL THAT APPLY):

- Auxiliary Heat (Internal _____, External _____, kW _____)
- Hot Water Assist: _____
- Electronic Air Cleaner (Brand: _____)
- Electrostatic Air Filter (Brand: _____)
- Zone Control (Brand: _____, # zones _____)
- Humidifier (Brand: _____)
- Other: _____

Warranty Registration

In order to receive full warranty benefits, it is necessary to register your unit.

There are two easy ways to register--

1. Register on-line at: www.wfionline.info
or
2. Complete the Warranty Registration Card to the right, tear out and mail.

Note: We respect your privacy. Please be assured that we will not provide your personal information to any outside company.

For your records --

I registered my warranty:

- Online (date _____)
 By mail (date _____)

Thank you!

What warranty do I have?

Overall term of warranty: _____ Years
Term of Parts warranty: _____ Years
Term of Compressor warranty: _____ Years
Term of Labor Allowance on warranted parts: _____ Years
Term of Labor Allowance on compressor : _____ Years
Term of Workmanship and dealer supplied materials: _____ Months

Warranty for Accessories:

Item	Years
_____	_____
_____	_____
_____	_____
_____	_____
_____	_____

Warranty Registration

Owner's Name: _____

Installation Address

Street: _____

City: _____

State/Province: _____

Zip Code/Postal Code: _____

List **current** Mailing Address if **different** from above,

Street: _____

City: _____

State/Province: _____

Zip Code/Postal Code: _____

Other Required Information

E-mail: _____

Day Phone: _____

Date of Installation: _____

Dealer Name: _____

Model Number: _____

Serial Number: _____

Loop Type: Open Loop/Well Closed Loop

Installation: New Construction Replacement

We request the following information to help us achieve better communication to existing and potential customers. Your response is confidential.

Size of Home:

Under 1500 square ft. 2500 to 4000 square ft.

1500 to 2499 square ft. Over 4000 square ft.

Location of Home: Rural Suburban Urban

Value of Home: Under \$100,000

\$100,000 to \$200,000 \$200,001 to \$500,000

Over \$500,000

How did you hear about our products?

(Check all that apply.)

Print Advertisement Website

Radio Commercial TV Commercial Billboard

Open House or Field Day Home Show

Builder Utility Company Friend or Relative

Heating/Cooling Contractor Other: _____

What are the three most important reasons you decided to purchase a system?

Energy savings Comfort

Reliability/Low Maintenance Safety

Quiet Long Equipment Life Innovation

Rebate/Incentive Recommendation of Others

Environmentally Friendly Other: _____

Place
Stamp
Here

WATERFURNACE INTERNATIONAL
ATTN: WARRANTY REGISTRATION DEPT
9000 CONSERVATION WAY
FORT WAYNE IN 46809-9794

Table of Contents

WARRANTY REGISTRATION & RECORD.....(tear out card)	
GEOHERMAL SYSTEM TECHNOLOGY & BENEFITS	4
ABOUT YOUR WATERFURNACE SYSTEM	5-17
How Geothermal Systems Work	6-9
Typical Installation & Components	10-11
Closed Loop Systems	12
Your Loop Location	13
Open Loop Systems	14
Safety Warnings.....	15
Warranty Explanation.....	16
Warranty Certificate	17
THERMOSTATS.....	18
HOMEOWNER MAINTENANCE	19-20
TROUBLESHOOTING	21
FAQs, GENERAL INFORMATION & OPERATING TIPS.....	22-29
ENERGY SAVING TIPS	30
PRODUCT INFORMATION FOR UNITS & ACCESSORIES.....	31
Model Number & Serial Number Reference	32
Envision Series Unit Information.....	33
Envision Series Air Handler Information	34
Envision Series Outdoor Split Unit Information	35
EW Series Unit Information.....	36
Premier Unit Information	37
Premier and Envision Series Split Unit Information	38
Synergy3D Unit Information.....	39
Versatec Unit Information.....	40
Optional Hot Water Assist	41
Auxiliary Heater.....	42
Humidifier	43
AlpinePure ET.....	44
AlpinePure ES.....	45
AlpinePure HRV	46
AlpinePure HEPA.....	47
AlpinePure 211 & 411.....	48
Flow Center.....	49
IntelliZone	50
Other Accessories	51
WATERFURNACE PROMOTIONAL MERCHANDISE	52
GLOSSARY.....	53
PREVENTIVE MAINTENANCE SERVICE RECORD.....	54

GEOTHERMAL SYSTEM TECHNOLOGY & BENEFITS

Geothermal heating and cooling technology is ideal because it provides exceptional performance while being environmentally-friendly. Your investment in a WaterFurnace system will provide you with many years of benefits including:

Energy Savings

WaterFurnace units deliver 3 to 4 units of energy for every 1 unit of energy consumed. Many homeowners experience energy savings from 30% to 60% over other ordinary heating and cooling systems.

Cost Effective

Because of the extraordinary efficiency of a WaterFurnace system, any added investment related to installing a geothermal unit is usually more than offset by your energy savings.

Comfort

You'll experience consistent, precise temperature control without the hot blasts of air associated with gas furnaces or the cold blow of an air source heat pump.

Reliable

The WaterFurnace reputation for reliability has been earned by using only the highest quality components, design, and workmanship. Like your refrigerator, your geothermal unit will provide many years of worry free operation.

Quiet

Unlike ordinary air conditioners or heat pumps, there is no noisy outdoor unit. Our units are designed and constructed for "whisper quiet" operation, similar to your refrigerator.

Safe & Clean

WaterFurnace units don't burn fossil fuels, so there's no flame, fumes, combustion or concerns about carbon monoxide poisoning.

Environmentally Friendly

Your geothermal system doesn't release harmful greenhouse gasses into the air, unlike a fossil fuel burning furnace. The reduced energy consumption of a geothermal system further reduces the need for more coal-fired or nuclear power generating plants and places less demand on our current capability to produce electricity. Geothermal units use far less refrigerant than ordinary heat pumps or air conditioners, and are factory sealed to prevent leakage.

We're confident that your investment in a WaterFurnace system will provide you with many years of savings, comfort, and safe, clean, reliable, quiet operation.



ABOUT YOUR WATERFURNACE SYSTEM

This section includes some detailed information about how geothermal technology works, and how the different components used in the system work together to provide you with the finest comfort system available. You'll find useful information about the refrigeration process, loop systems, safety, and warranties.

Although the mechanics behind this technology may seem complicated, it's based on the same technology that's used for your refrigerator—it's simply a device that moves heat energy from one place to another. And because of the infinite heat storage ability of the earth, you have a free, unlimited supply of energy in your own yard. In fact, for every one unit of electricity the system consumes, four units of energy are provided free from the earth and delivered into your home. This energy flow can be easily represented by the diagram below.

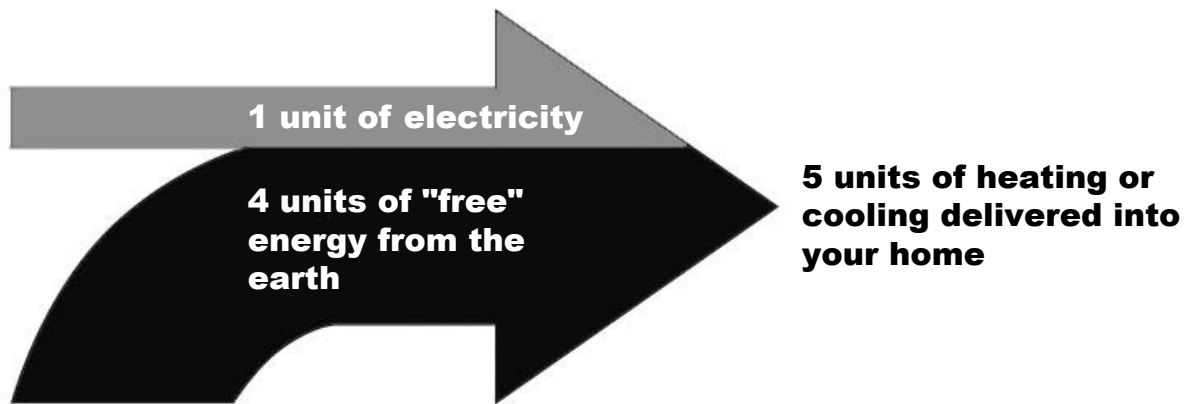

Interesting Facts

- According to the Environmental Protection Agency (EPA), GeoExchange technology is the most energy-efficient, environmentally-clean and cost-effective space conditioning system available.
- The EPA found that the systems can reduce energy consumption and corresponding emissions by over 40% compared to air source heat pumps and by over 70% compared to electric resistance heating with standard air conditioning equipment.
- If one in twelve California homes installed a GeoExchange system, the energy savings would equal nine new power plants.
- Installing a GeoExchange system in a typical home is equal, in greenhouse gas reduction, to planting an acre of trees, or taking two cars off the road.
- Current GeoExchange installations equal 14 million barrels of crude oil saved per year.
- The ground absorbs 47% of the sun's energy that reaches the earth. This amount of energy represents 500 times more than mankind needs every year.

HOW GEOTHERMAL SYSTEMS WORK

The Interesting Basics...

Geothermal heat pumps utilize some of the same technology found in your home's refrigerator. They are both devices that move heat energy. Your refrigerator removes heat from the food and transfers it to the air in your home. Your geothermal heat pump removes heat energy from the earth to heat your home and removes heat energy from inside your home to cool it.

A Ground Source Heat Pump System consists of a water-to-air or water-to-water heat pump, connected to a series of long plastic pipe buried below the earth's surface, or placed in a pond. These systems can also utilize well water instead of the earth loop. As fluid from the earth loop or well water is moved through the unit, the heat pump transfers thermal energy that heats or cools the home or building.

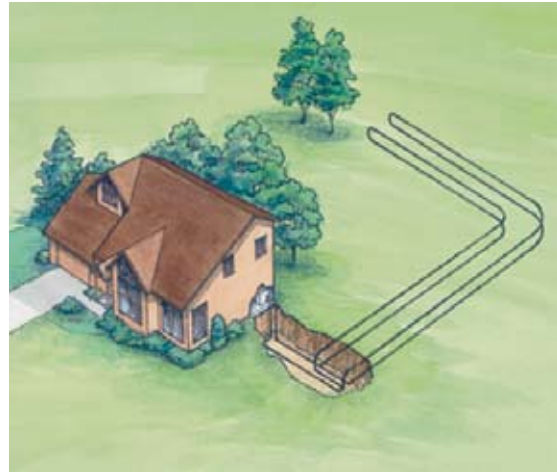

The ground serves as a giant solar collector, storing heat energy. At depths greater than 30 feet deep, the temperature is about the same as the average annual outdoor air temperature for that climate. Air temperatures may fluctuate as much as 50° F above and below the average annual temperature. However, only a few feet below the surface, the changes in earth temperatures are much less severe. Earth temperature variations decrease with increasing depth. During heating, the earth serves as a heat source. During cooling, the earth serves as a heat sink.

The earth loop is placed in the ground either horizontally or vertically, or it can be placed in a pond. Water (or water and anti-freeze) is circulated through the pipe, transporting heat to the heat pump during the heating mode and away from the heat pump during the cooling mode. The heat transfer takes place inside the heat pump in a water-to-refrigerant heat exchanger.

The Boring Details...

HEAT PUMP OPERATION

Geothermal heat pump systems consist of four circuits:

1. Air circuit—The duct system that distributes the air throughout the home or building and returns it to the unit.
2. Refrigerant circuit—A sealed and pressurized circuit of refrigerant including compressor, expansion valve, water-to-refrigerant heat exchanger, air coil, reversing valve. The refrigerant is either R-22 or R-410A.
3. Ground loop circuit—The piping system buried in the ground or in the pond (or well water), with fluid that is circulated by pumps to and from the geothermal unit.
4. Hot water circuit—Domestic water can be heated in a geothermal unit with a device called a desuperheater. A piping connection is made from the geothermal unit to the water heater.

Each of these circuits is closed and sealed from the others—there is no direct mixing. However, heat energy **does** mix from the refrigeration circuit to the other three circuits.

The air circuit, the earth loop circuit, and the domestic hot water circuit always travel in the same direction. However, the refrigeration circuit will change direction depending on what mode (heating or cooling) the unit is in. (The exception to the change in direction of refrigerant flow is the flow through the compressor. This change of direction is controlled by the reversing valve.)

Heating Mode

During heating, a geothermal system absorbs the heat from the ground via the earth loop. The heating cycle starts as cold, liquid refrigerant passes through the water-to-refrigerant heat exchanger (coax, and also the evaporator during heating). The coax is made of copper (or copper and nickel) and consists of a tube within a tube—water from the loop travels through one tube (the inside tube), refrigerant passes through the other (outer) tube.

As the loop fluid flows through the coax, the heat energy transfers from the loop fluid to the refrigerant through the copper wall separating the two. This heat transfer causes the cold liquid refrigerant to turn into a gas. (Unlike water, refrigerant changes from a liquid into a gas at a very low temperature.) The now gaseous refrigerant is sucked into the compressor where it is compressed. After compression, the refrigerant will be very hot (approximately 165° F) and discharged through the reversing valve and into the air coil.

The air coil is a radiator-like device that has thin aluminum “fins” attached to the copper refrigerant tubing. The refrigerant passes through the air coil (the condenser during heating). As air from the return air duct system passes over the air coil, heat is released from the refrigerant and absorbed by the cooler air. The result is warm air (typically 95° to 105° F) which is delivered through the duct system by the blower.

The refrigerant, now cooled again, passes through the expansion valve (which acts as a flow control), returning to the coax where it can accept more heat from the warmer loop fluid.

This process is continuous during the heating mode.

Heating Operation

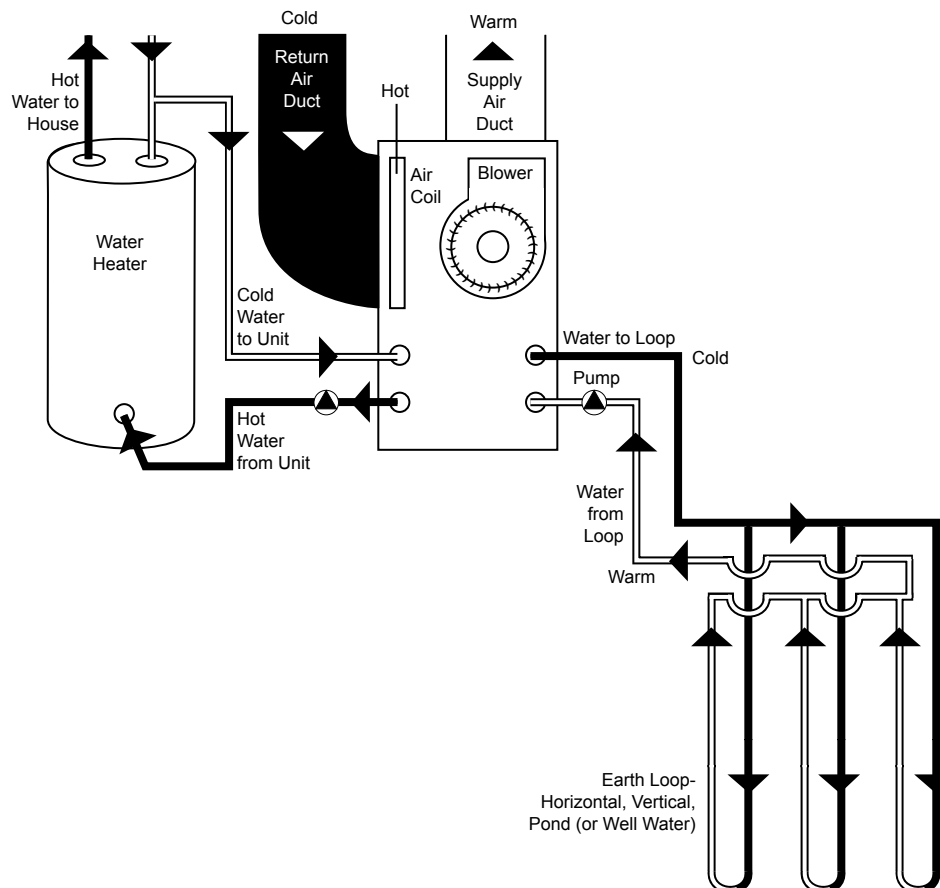

Cooling Mode

During cooling, a geothermal system rejects the heat from the indoor air into the earth loop. The cooling cycle starts as cold, liquid refrigerant passes through the air coil (the evaporator during cooling).

As the refrigerant flows through the air coil, the heat energy transfers from the warm return air to the refrigerant. This heat transfer causes the cold liquid refrigerant to turn into a gas. The compressor draws the refrigerant gas, compresses it, and discharges it through the reversing valve. During cooling, the reversing valve is energized, which changes the openings from one port to another, causing the refrigerant flow to go in the opposite direction that it was in the heating mode. (However, the flow to the compressor does not change direction.)

After compression, the hot refrigerant passes through the coax (the condenser during cooling). In the coax, the hot refrigerant releases its heat energy to the cool loop fluid through the copper walls. Now cooled and liquified, the refrigerant passes through the expansion valve, back to the air coil. Warm air passing over the cool air coil causes the air to be cooled and dehumidified.

This process is continuous during the cooling mode.

Cooling Operation

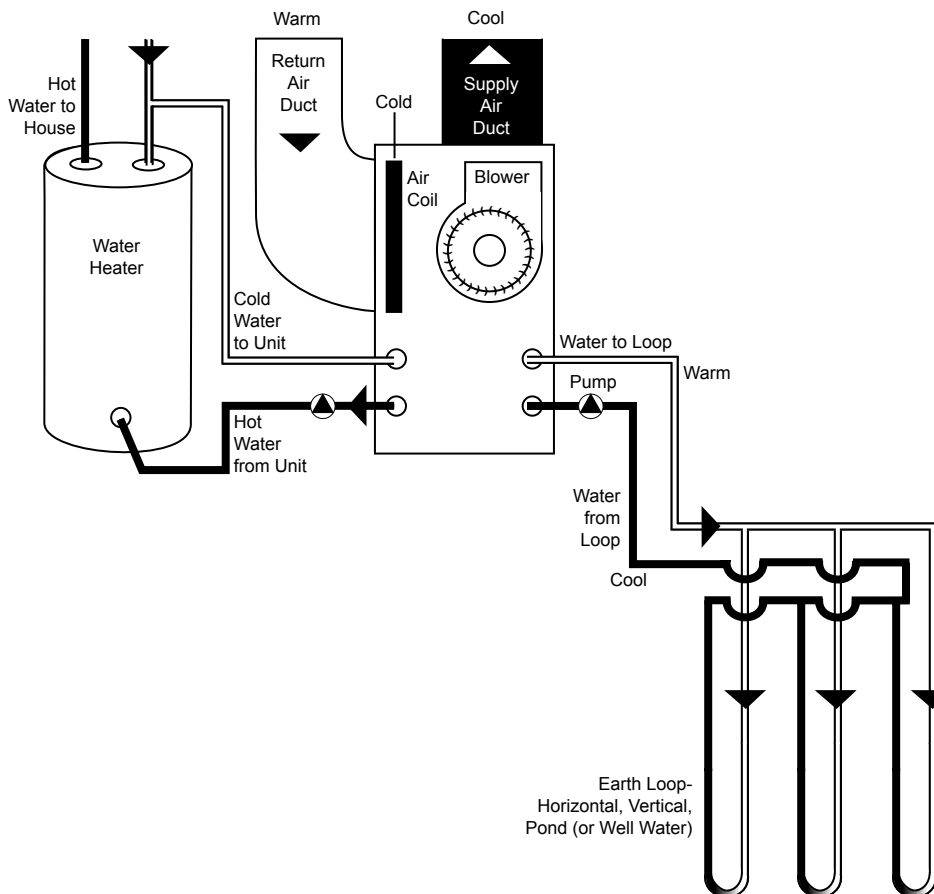

Hot Water Assist

Many geothermal units installed in homes have an optional feature called a **hot water generator**. This component removes excess heat from the refrigerant circuit and adds it to a hot water circuit in the unit. For more information refer to page 40.

It is important to note that the Hot Water Assist function simply *assists* in *preheating* water. The temperature rise through the unit is generally 5 -10° F.

The amount of hot water generated is a function of the model and run time of the unit. On very hot days and cold days, the hot water generator could produce more hot water than is required for the home due to the long run times of the unit. On milder days when the unit has short duty cycles, the electric elements in the water heater will maintain the desired temperature so there will always be enough hot water for the homeowner.

Some installations use a single tank for storage of hot water. Other installations use two tanks to provide extra hot water capacity with added efficiency.

Typical Desuperheater Installation

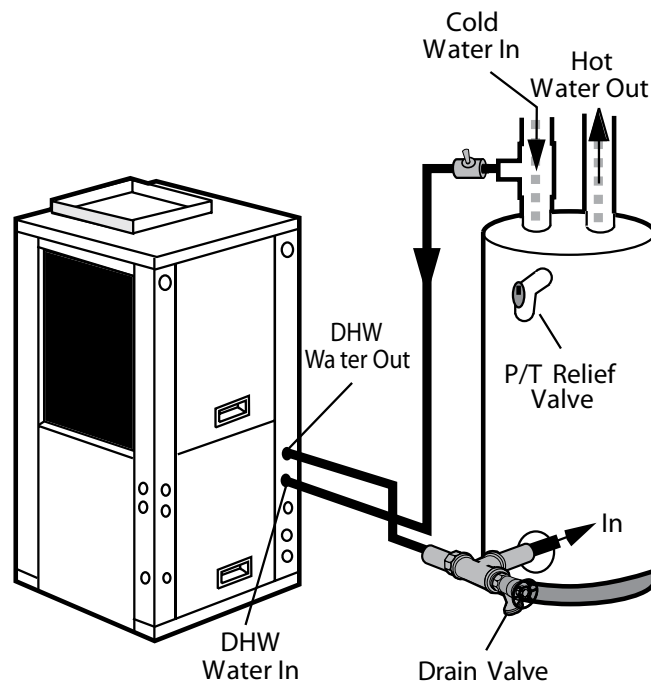

TYPICAL INSTALLATION AND COMPONENTS

Your geothermal system is actually a collection of components working together to perform the heating, cooling and water heating functions. The basic system includes the unit, power supply, a control component, the water circuit and a distribution method. Many additional optional accessories are available, but listed below are the basic components used in most every installation.

Closed Loop Components

Major components in a closed loop earth coupled system include:

- Geothermal unit placed on mounting pad
- Thermostat
- Earth loop piping
- Earth loop circulators (pumps)
- Electrical supply
- Duct system (except for radiant floor heating systems)
- Hot water piping (if hot water generator used)
- Auxiliary heater (if used)

Typical Closed Loop System

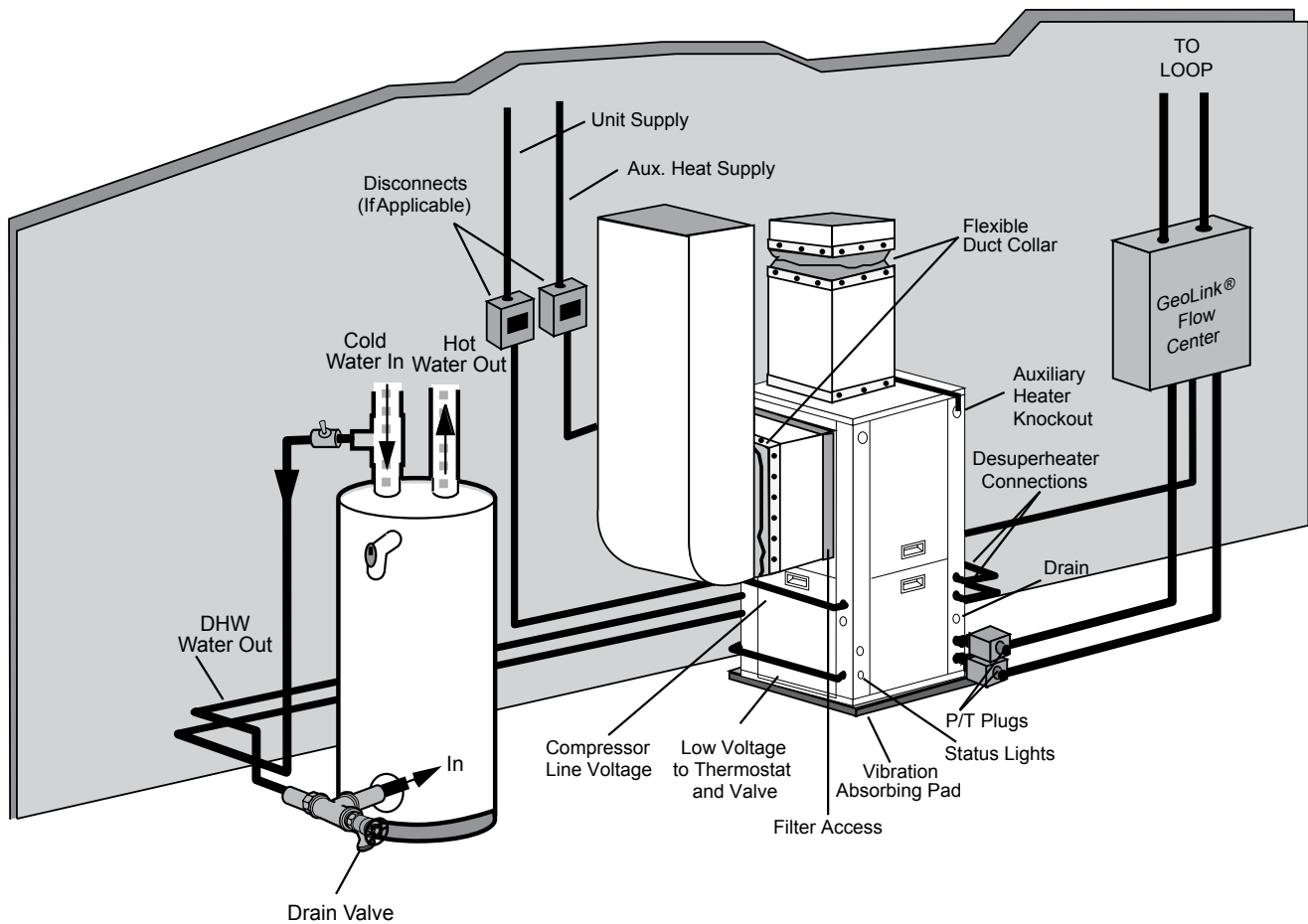

Open Loop Components

Major components in an open loop/well system include:

- Geothermal unit placed on mounting pad
- Thermostat
- Well & pump
- Pressure tank
- Supply water piping
- Discharge water piping with solenoid valves and flow regulators
- Shut-off/isolation valves and drain valves
- Electrical supply
- Duct system (except for radiant floor heating systems)
- Hot water piping (if hot water generator used)
- Auxiliary heater (if used)

Typical Open Loop System

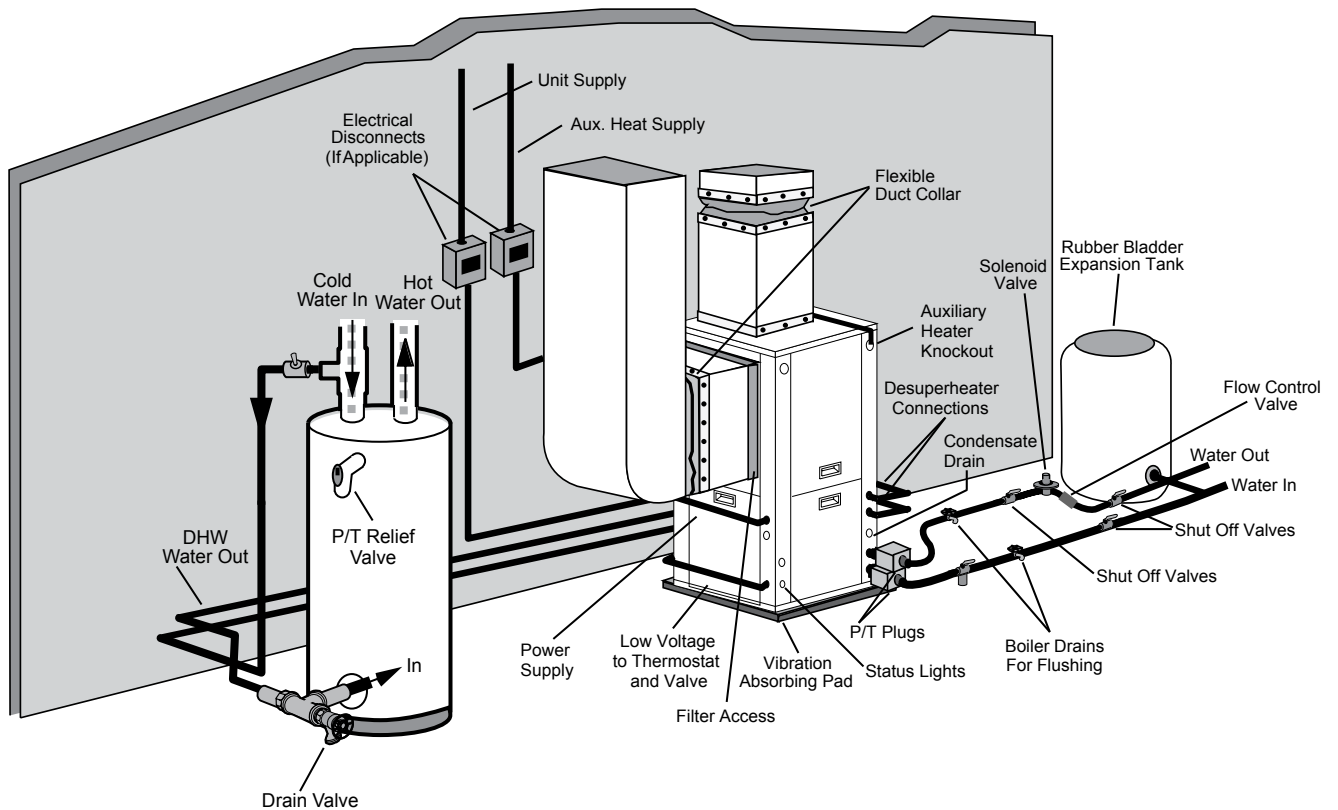

Closed Loop Systems

Horizontal Loops

Horizontal earth loops are used where the space allowed for the loop is not extremely limited. There are various designs of horizontal loops. There is not one type of horizontal loop that is best for every application. The selection of which type to use should be based on system size, space available, soil conditions and the type of excavating equipment used. Regardless of the type selected, operating costs will not vary substantially.

If you have this loop type, record information here:

Number of trenches or horizontal bores: _____

Length of each trench: _____

Number of pipes in trench: _____ Pipe size: _____

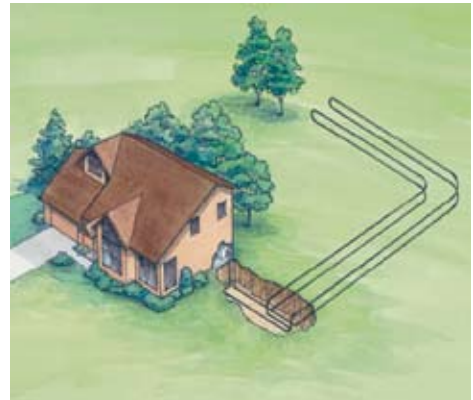

Vertical Loops

Vertical loops are used where space is limited or where soil conditions are not conducive to horizontal loops. Installing vertical loops requires the use of a drilling rig. Multiple holes are bored. A double pipe connected with a U-bend is inserted into each hole. The hole is filled with grout to provide good contact around the pipe and to seal the hole. The vertical pipes are then connected to a header system horizontally a few feet below the surface.

If you have this loop type, record information here:

Number of bore holes: _____

Depth of each bore hole: _____ Pipe size: _____



Pond Loops

Pond loops are a cost effective way to install a geothermal system, because trenching is limited to only the supply and return piping from the pond to the house.

Pond loops consist of a series of coils connected together, and placed at the bottom of the pond. In order for a pond to be suitable for a geothermal application for a typical home, the pond should be at least ½ acre in surface area and at least 8 ft. deep, even during a dry spell. Ideally, the pond should be close to the home (less than 200 ft.). If the pond is farther from the home, the benefit of using a pond loop is reduced due to added trenching, materials and pumping costs.

If you have this loop type, record information here:

Number of coils: _____ Pipe size: _____

Depth of pond where coils are located: _____

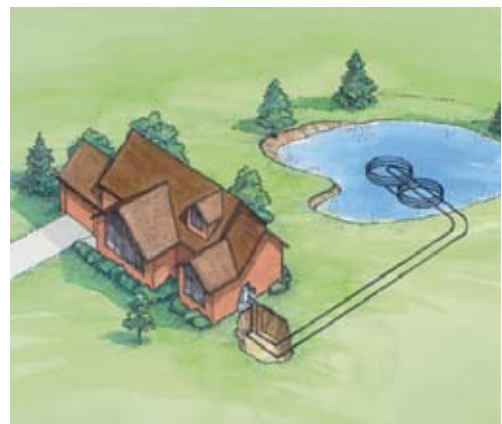

Water Supply for all Closed Loops

Closed loops require no regular maintenance. However, if you notice air noise within the piping or if your loop is ever damaged by excavation, contact your dealer.

Your Loop Location

It is strongly recommended that you have a record of the location of your earth loop. Using the grid below, draw a bird's eye view of the property where the loop is located. Include the house and measurements from various points so that there is no question about the location of the piping system. You may also want to include the location of any underground utilities.

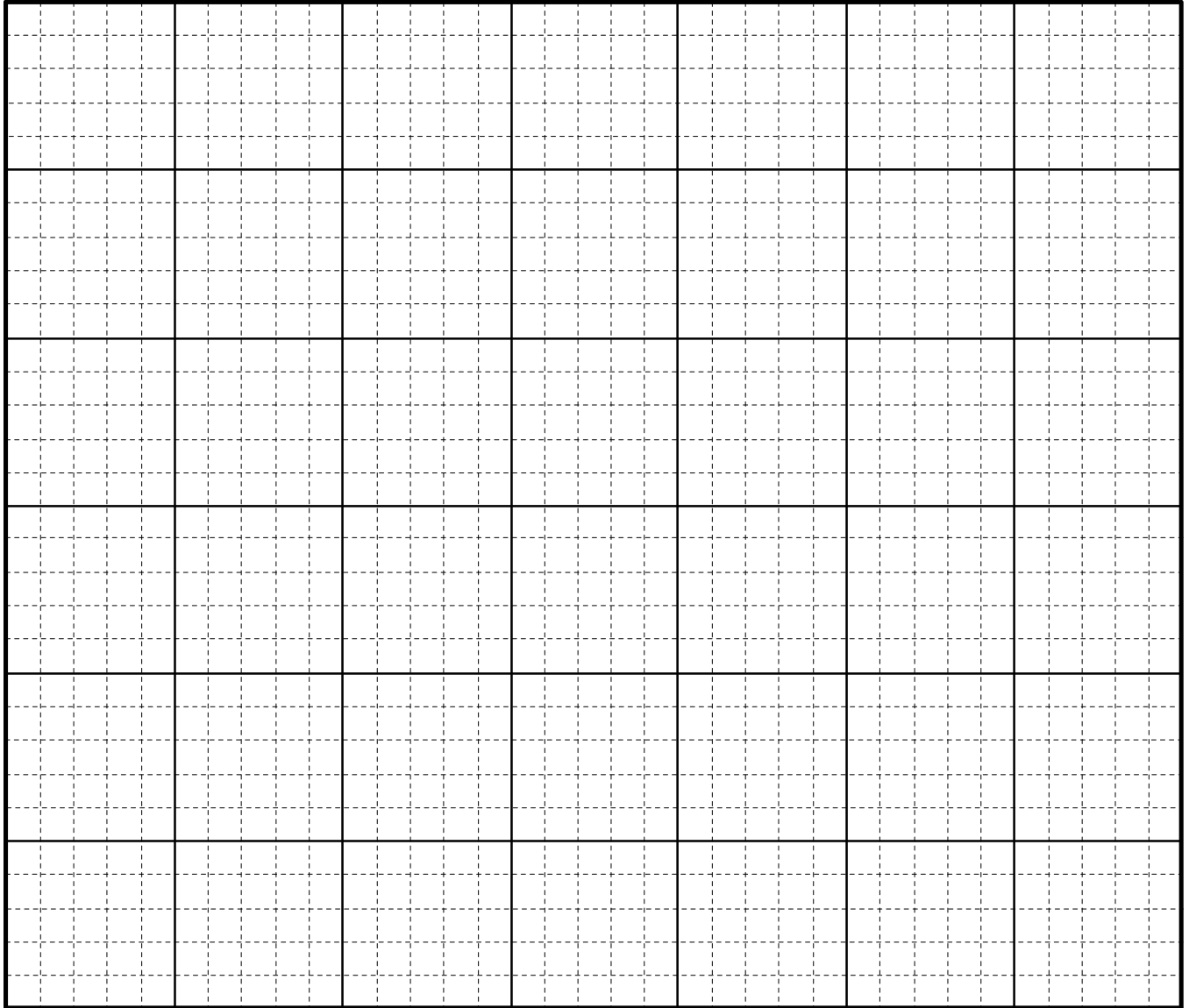

Scale: 1 square equals ___ ft.

<input type="checkbox"/> 2 Pipe <input type="checkbox"/> Backhoe <input type="checkbox"/> Trench Width = _____ Depth = _____, _____	<input type="checkbox"/> 4 Pipe <input type="checkbox"/> 6 Pipe Width = _____ Depth = _____, _____	<input type="checkbox"/> Other Width = _____ Depth = _____, _____	<input type="checkbox"/> 1 Pair Vertical Backfill = _____ Depth = _____
--	--	---	---

Open Loop Systems



Open Loop or Well Water Systems

An alternative to closed loops are open loop systems, also known as well-water systems. If your system is an open loop, it uses water that comes into your home from your well. Water from the well is circulated through the unit whenever the unit is heating or cooling. When the unit is not running, it is not using any water.

Once the water has run through the unit, it is discharged into a location like a pond, drainage ditch, field tile, etc. Water used in the unit is not re-used for other domestic purposes.

If you have an open loop, record information here:

Total Domestic System designed for _____ gpm.

Geothermal System designed for _____ gpm.

Well depth: _____ ft. Pump depth: _____ ft.

Water table depth: _____ ft. Pump HP: _____

Well yield: _____ gpm

Unit Maintenance with Open Loop Systems

Depending on the water quality, some maintenance is usually required with a well water system. Because of minerals and other particles in the water, without a routine of preventive maintenance, this material may eventually begin to clog the heat exchanger in the unit. When this happens, the efficiency and capacity of the unit is decreased, eventually to the point where failure may occur.

To minimize the potential of this happening, a heat exchanger cleaning schedule should be established with your dealer. The frequency will depend on the specific quality of your well water. Some homeowners find that they can go a few years between cleanings; others may need to have the heat exchanger cleaned yearly. In order to achieve optimum performance, energy savings and long system life, it is necessary to have your dealer perform this service as needed. Remember-- preventive maintenance is less expensive than replacing major components.

The cleaning procedure requires special equipment and chemicals. Therefore, do not attempt to clean the heat exchanger yourself.

Water Supply

An adequate water supply to the unit is very important. Do not let anyone disrupt the water supply by rerouting the supply line or tapping into it without first checking with your dealer. If the well pumping system requires service or is inoperable, your unit should be turned off or placed into emergency heat until an adequate water supply is restored.

Safety Warnings



WARNING: Equipment used for heating, air conditioning and water heating can cause injury if safety precautions are not observed. These systems generally use a 230 volt power supply which is double the voltage used by other household appliances. Electrical shock from these systems could cause personal injury or death. Before performing any service or maintenance operations on a system, turn off main power switches to the unit, and turn off the auxiliary heater power also if used.

Although your geothermal unit has been designed and manufactured with your safety in mind, and is certified to the safety standards of ETL, failure to observe safety precautions can result in injury. Only trained and qualified service personnel should install, repair, service or adjust heating and air conditioning equipment. Untrained personnel can perform the basic maintenance functions listed below. All other operations should be performed by trained service personnel. When working on heating and air conditioning equipment, observe precautions in the literature, tags and labels attached to the unit and any other safety precautions that may apply.



Do not allow children or pets to play around the unit.

Safety Precautions

When performing the following functions, adhere to these safety precautions:

- Replacing a disposable filter — Turn off the unit and fan at the thermostat.
- Cleaning an electrostatic filter — Turn off the unit and fan at the thermostat
- Cleaning an electronic air cleaner — Turn off all power supplies to the unit and the air cleaner. Wait 5 minutes to allow static to discharge.
- Checking or cleaning the internal condensate drain pan — Turn off all power supplies to the unit, and be careful around the sharp fin edges of the air coil. Wear safety glasses and work gloves. Do not allow water to drip onto electrical components in the unit.
- Cleaning or replacing media for unit-mounted or duct-mounted humidifiers — Turn off all power supplies to the unit and humidifier.
- Cleaning thermostats — Do not spray cleaning solution directly onto the thermostat. Wipe down with a damp cloth.
- Cleaning units — Turn off all power supplies to the unit. Do not spray water or cleaning solutions directly onto the unit. Wipe down with a damp cloth.

Breaker Box



Disconnect Box



Safety Tips

We want you and your family to be safe in your home. Here are some additional useful safety tips:

- Have working smoke detectors (replace batteries two times each year).
- Have working carbon monoxide detectors (even in all-electric homes).
- Have fire extinguishers available in kitchen, utility room, garage, etc.
- Have a well-stocked first aid kit available.
- Have an emergency/evacuation plan in place for all members of the family.

Warranty Explanation and Coverage

What about my warranty?

WaterFurnace offers the best warranty in the industry!

Our standard warranty provides coverage for all unit parts for a period of 10 years. In addition to replacement parts coverage, your servicing dealer receives a repair or replacement labor allowance on warranted components in the unit. However, WaterFurnace also offers several other warranty options, depending on the needs of the customer.

Your independent WaterFurnace dealer should have previously discussed with you the terms of these options, and together, you have selected the one that best fits your needs. Not all customers select the 10-year coverage, so if you are unsure as to your warranty period, contact your WaterFurnace dealer.

What items are covered under the warranty?

Our standard warranty covers parts and most accessories. "Parts" are considered to be any factory-installed component inside the unit including, but not limited to the compressor, reversing valve, expansion valve, electrical components, air coil, heat exchanger, etc. Upon failure of a part, the company provides a replacement part to the servicing contractor at no charge. "Accessories" are generally external to the unit and include items like thermostats, pumps, humidifiers, etc. In most cases, accessories supplied by WaterFurnace carry a 5 year warranty. Some warranties do not cover accessories. Contact your dealer to determine the specific terms and extent of your coverage.

Will I have to pay labor costs for warranty repairs?

Some warranty options include a Labor Allowance, which is an amount credited to your servicing company based on the type of repair made. The Labor Allowance is designed to **reduce** the cost of repairs. However, it may not cover the entire labor fee charged by your dealer. Not all warranty options include a labor allowance.

Warranty Certificate

How do I obtain the Warranty Certificate?

Your Warranty Registration Card (see tear-out card in the front of this document) must be completed and returned to WaterFurnace International immediately after installation to receive full warranty benefits. Upon receiving your warranty registration card, we will mail your Warranty Certificate (see sample below). Please read the warranty certificate carefully to familiarize yourself with the terms of the warranty so that you can obtain full benefits and avoid misunderstandings. If you have any questions about warranty coverage, contact your WaterFurnace dealer.

Sample Warranty Certificate

		RESIDENTIAL WARRANTY CERTIFICATE
<p>LIMITED</p> <p>TEN YEAR</p> <p>(WE10PL-3) (WE10PL-6)</p>	<p>A. TEN YEAR WARRANTY WaterFurnace International, Inc. (WFI) warrants your WaterFurnace heat pump to be free from manufacturing defects for a period of ten years from the date of original purchase. Unit accessories supplied by WFI are covered under this certificate for a period of five years. (Example items: Flow centers, thermostats and solenoid valves. Exception: Desert Spring Humidifier -- 1 year).</p> <p>B. REMEDY At its option and without charge for the part, WFI will provide either a new or rebuilt part of the unit or accessory in exchange for any part which fails because of a defect covered under the terms of this warranty. WFI will not pay the cost of transportation, field labor and materials; however, if a defective part covered under the terms of this warranty is repaired or replaced, a repair/replacement labor allowance is available.</p> <p>WFI neither assumes nor authorizes any person to assume for it any obligation or warranty other than those set forth in this warranty.</p> <p>C. CONDITIONS <i>This warranty is void if your unit has been misused, abused, or altered in any manner.</i> WFI shall not be liable under this warranty or otherwise, for parts which fail because of misapplications, improper installation, improper voltage, improper maintenance or repair, corrosion, or acts of God. WFI shall not be liable for performance related issues resulting from improper installation, improper sizing, improper duct or distribution system, or other installation deficiencies.</p> <p>D. YOUR RESPONSIBILITIES Your warranty protection begins on the date of original purchase. You should retain your sales contract or other proof of purchase to establish that date. Return the warranty registration card to WaterFurnace International, Inc., 9000 Conservation Way, Fort Wayne, Indiana 46809. If the warranty registration card is not returned, the date of original purchase shall be presumed to be the date your unit was shipped from WFI. To transfer the warranty from one owner to another, notify the Warranty Department at WaterFurnace International, Inc. at the above address.</p> <p>E. WARRANTY PERFORMANCE To make a claim under this warranty, you must promptly notify your WaterFurnace Dealer with a detailed explanation of the problem. If additional assistance is required, contact the Warranty Department, WaterFurnace International, Inc., 9000 Conservation Way, Fort Wayne, Indiana 46809 or call 260-478-5667.</p> <p>F. LIMITATIONS <i>The remedies of repair or replacement set forth above are the sole and exclusive remedies for breach of this warranty, or any implied warranty arising under law. WFI shall not be liable for any incidental or consequential damages in connection with this unit except to the extent required by law. In no event shall any implied warranties remain in effect after the expiration of this warranty.</i> Some states do not allow the exclusion or limitation of incidental or consequential damages, or limitations on how long an implied warranty lasts, so the above limitations or exclusions may not apply to you.</p>	<p>UNIT SERIAL NUMBER</p> <hr/> <p>WaterFurnace International, Inc. 9000 Conservation Way Fort Wayne, IN 46809-9794</p> <p>Visit us at waterfurnace.com WFWE10PL 07/06 THIS WARRANTY GIVES YOU SPECIFIC LEGAL RIGHTS, AND YOU MAY ALSO HAVE OTHER RIGHTS WHICH VARY FROM STATE TO STATE.</p>

Note: Your Warranty Certificate may be different depending on the warranty purchased. The certificate shown above is not intended to convey legal terms of your actual warranty. Reference the certificate that you will receive after registering your product for the specific terms of your warranty.

THERMOSTATS

The main control (or interface) between you and your WaterFurnace unit is the thermostat. Electronic thermostats are widely used in today's heating and cooling systems, replacing old electro-mechanical models containing mercury. In addition to providing more precise temperature control, electronic thermostats can also include many more features and options, along with a more aesthetically-pleasing look. Although these thermostats are significantly more high tech, you'll find that they are easy to operate.

Note: Most thermostats have an automatic minimum temperature separation (in degrees) from the heating setpoint to the cooling setpoint. This is necessary so the unit cannot continuously switch back and forth between heating and cooling when the thermostat is set in the automatic changeover mode. This separation is called the "dead band", and is usually 2 degrees F. For example, if you place your cooling setpoint at 72, your heating setpoint cannot be higher than 70. If you would then increase your heating setpoint from 70 to 72, your cooling setpoint would automatically increase by that same 2 degrees to 74.

Your electronic thermostat is designed to provide precise comfort. To get the best comfort from your system it is recommended that you resist the temptation to frequently adjust the thermostat. Simply find a comfortable setting for heating and cooling, and let the system do the rest to provide you with many years of energy savings without sacrificing comfort. Most homeowners prefer setpoints in heating from 70 to 72, and from 73 to 75 during cooling.

Thermostat Owners Manuals

If you need to obtain an owner's manual for the thermostat installed with your WaterFurnace unit, please visit:

www.waterfurnace.com/thermostats



HOMEOWNER MAINTENANCE

Your investment in a WaterFurnace geothermal system was a significant expenditure. While these systems are among the most reliable HVAC systems available, your WaterFurnace system (and any other HVAC system) must be properly maintained in order to achieve maximum performance and long system life (like your automobile). It is recommended that you have your system thoroughly checked by your dealer twice per year (usually Spring and Fall) to maintain optimum performance. If your dealer offers a maintenance agreement program, we suggest you take advantage of it. Regular checks will ensure that your system performs safely and efficiently, with less likelihood of major problems and premature failure.

Things You Can Do

1. Keep your filter clean

- **Standard Disposable Filters (Replace every 2-4 months)** -- If you use disposable filters, change them regularly, *before* they accumulate too much dirt. Do not attempt to *clean* a disposable filter. Simply throw it away and reinstall a new one. Do not turn a dirty filter over to the clean side and reinstall it-- this results in blowing the accumulated dirt right back into the home. Disposable filters can be purchased at most hardware stores or through your local WaterFurnace dealer.
- **Pleated Disposable Filters (Replace 1" filters every 2-4 months; Replace 2" & 4" filters every 4-6 months)** -- If you use pleated filters, change them regularly, *before* they accumulate too much dirt. Do not attempt to *clean* a pleated filter. Simply throw it away and reinstall a new one. Pleated filters can be purchased from your WaterFurnace dealer.
- **Electrostatic Filters (Clean every 1-2 months)** -- If you use an electrostatic filter, clean it regularly. See page 54 for instructions.
- **Electronic Air Cleaners (Clean and replace media every 2-4 months)** -- If you have an electronic air cleaner, replace the filter media according to the manufacturer's instructions. See page 43.

2. Check Drain Pan (Once per year during heavy cooling periods)

The drain pan accumulates water that has condensed on the air coil during cooling to provide dehumidification. Occasionally, the drain hole in the pan (or the drain hose) can become clogged, and this will most likely occur during the cooling season. See page 25 for cleaning instructions.

3. Check Duct Work (Once per year)

A recent study found that many homes had a least one section of duct disconnected resulting in the blowing of conditioned air into attics or crawl spaces. Check any visible duct work, especially in attics or crawl spaces, for disconnected sections or large leaks. Check registers in every room for air flow and to ensure they are open.

4. Check Thermostat (Once per month)

Check your thermostat to ensure that there are no fault signals being displayed or that Emergency Heat is not being engaged. If you have selected Constant Fan on your thermostat, your operating cost will be affected more (they will be higher) if your unit is equipped with a single speed PSC blower instead of a variable speed ECM blower.

5. Check the Unit (Twice per year)

Check for LEDs that are ON (see page 24)

Check for moisture around the base of the unit or the flow center

Check for anything appearing or sounding unusual

6. Check Accessories (Twice per year)

Check for proper operation and for anything appearing or sounding unusual.

Maintenance Schedule

	Monthly	1-2 Months	2-4 Months	4-6 Months	Yearly
Replace disposable filter (1")			●		
Replace disposable filter (2" & 4")				●	
Clean electrostatic filter (if used)		●			
Clean electronic air cleaner (if used)			●		
Check condensate drain pan					●
Check duct system					●
Check thermostat operation and signals	●				
Visual check of unit & LEDs				●	
Visual check of accessories				●	

TROUBLESHOOTING

In the event that your unit is not functioning properly, check the fault lights and troubleshooting information below. After determining that a service call is required, call your dealer for an appointment. When calling the dealer, it is beneficial to provide your model number (see inside front cover or page 32) and indicate any fault lights that are "on" either at the unit or on the thermostat.

Troubleshooting Reference

Symptom/Problem	What You Can Do	Reference Pages
Unit not operating.	Check status/fault lights.	23 - 25
Unit not heating or cooling adequately.	Check filter and status/fault lights.	23 - 25
Unit just "hums" and doesn't heat or cool.	Disconnect power. Call for service.	
Electric bills too high.	Is unit always in Emergency Heat?	26
	Is thermostat set to Continuous Fan when using PSC blower?	26
One room is too cold/hot.	Check for closed registers and disconnected duct.	28, 30
Too much air flow.	Check for closed registers in other areas.	28
Whistling noise coming from fan.	Check filter.	25
Loop has been damaged.	Turn off unit at breaker. Call for service.	26
Thermostat settings "mysteriously" change.	Check setpoints for both heating and cooling.	18
Red LED on at thermostat.	Check status/fault lights on unit. See thermostat instructions.	23 - 24 18
Red LED on or flashing at unit.	Determine fault condition by noting which light is on.	23, 24
Drain light is flashing.	Check condensate pan and drain.	24, 25

FREQUENTLY ASKED QUESTIONS, GENERAL INFORMATION AND OPERATING TIPS

The following section (pages 23 to 29) includes the most frequently asked questions (FAQs). It also includes operating tips, other information and how to get the best results in comfort, savings, and reliability.

If this is your first ownership experience with a geothermal system, you'll find this information valuable. Geothermal systems do function differently than ordinary systems. However, by using this section as a reference, you'll be able to find answers to the most common questions.

We've also included some information and tips on how to save additional heating and cooling costs throughout your home in ways that don't include your geothermal system. We want your geothermal ownership experience to be something that you'll enjoy (and benefit from) for many years.

Frequently Asked Questions (FAQs)

What about my thermostat operation?

Your unit is controlled by one or more thermostats. Thermostats sense the temperature in the room in which they are located and determine the mode of the unit (heating or cooling) and control the duration of the cycle. WaterFurnace offers a variety of thermostats, each one operates on the same principle but their settings, buttons and commands are different.

For more information on the thermostats offered by WaterFurnace, visit: waterfurnace.com/thermostats.

What do I do in case of a power failure?

Don't worry. Today's electronic thermostats employ the latest developments in solid-state technology. Most electronic thermostats do not require a battery in order to maintain your selected set points in the event of a power loss. The thermostat memory is unaffected by power failures of any duration. When power is restored, the thermostat will continue operating as if the power had never been interrupted. However, there will be no heating or cooling during the outage.

What if my unit stops working?

Your unit has been equipped with a variety of self-protection devices and controls. Should you suspect that heating or cooling operation has ceased, look at the thermostat to see if the unit lockout indicator light is illuminated. If the lockout indicator light is illuminated, see resetting the unit section, page 24.

What about regular service?

Your system requires little regular maintenance. However, once a year or so, have the unit inspected by your dealer. They will check the unit's performance and make sure that your unit is heating and cooling at its peak performance level. If your system is using a well as its water supply, your unit may need periodic cleaning to remove mineral deposits.

What kind of safety controls does my unit have?

Your WaterFurnace unit is equipped with safety controls which are designed to protect the unit in case of improper airflow, water flow or refrigerant charge. These safety controls should not be bypassed. Doing so may void the warranty.

What are the lights for?

Some models are equipped with STATUS lights. These lights are mounted in plain view on the front of your unit. They will help you properly identify any problems and determine what might be required to correct the situation.

These lights will:

- Help determine whether your system is operating correctly.
- Help identify any problems.
- Help determine if you can fix the problem yourself and avoid a service call.
- Save you time and expense when you need to call an independent WaterFurnace dealer by helping them identify the problem before they come out.

Status Lights



What do the status lights indicate?

In general, red LEDs continuously illuminated indicate the unit is attempting to self-correct a fault. Flashing red LEDs indicate the unit has locked out in a fault mode. In this case, Emergency Heat will be activated. Call your dealer for service after reviewing the specific fault information below:

Drain

When this light comes on, it indicates that the condensate drain pan within the unit has reached the overflow level. This may be caused by foreign matter blocking the drain pan opening, or a clog in the drain line. See page 25 for cleaning procedure

Water Flow

A sensor protects your unit against internal freeze up caused by a water flow loss in the heating mode. When the WATER FLOW light is on, this signals that internal freezing conditions have occurred. This may be caused by a pump failure, low antifreeze level or air pockets in the loop piping (see resetting the unit section, below).

High Pressure

When this light is on, it indicates high refrigerant pressure. This may be caused by a loss of water flow in the cooling mode or low airflow in the heating mode caused by a dirty filter.

Low Pressure

When this light is on, it indicates a loss in refrigerant pressure in the system. This may be caused by a refrigerant leak (see resetting the unit section, below) or a dirty filter in the cooling mode.

Airflow

When this light is on, it indicates either a dirty filter or an airflow problem. Clean/replace air filter. Contact your WaterFurnace dealer if problem persists.

Status

A blinking green STATUS light indicates that the microprocessor control, which is the “brain” of the unit, is operating properly. If the light doesn’t flash but remains continuously on or off, the control is inoperative. Turn off all power to the unit, including auxiliary heat, and then turn it back on. If the light remains continuously on or off, call your WaterFurnace dealer.

DHW Limit

A sensor monitors the temperature of the water leaving the unit. The light will come on if the temperature is above 130°F (54°C). At this time your unit’s hot water pump will be de-energized to prevent excessive temperatures. Don’t worry; hot water operation will resume when the tank cools off. This is not a fault condition, and the unit does not require resetting.

DHW Pump Switch

When this switch is off, your unit’s hot water pump is manually disabled, and DHW OFF status light will be lit. This switch may be used when the water heater is being serviced or replaced. This switch must be turned off when water flow from the water heater to the unit is turned off or disconnected. Damage to the pump may otherwise occur.

Status Lights



If my unit shuts off, how do I reset it?

- To reset the unit, repeatedly push the SYSTEM button on the thermostat until the display reads OFF.
- The unit lockout indicator light will remain on for up to 15 seconds after turning the system off.
- After the unit lockout indicator light goes out, turn the system back on to the desired MODE.
- Unit operation should resume within five minutes if heating or cooling is required.
- The appropriate status light on the unit will continue indicating the fault until power is interrupted to the unit. This serves as a diagnostic aid for your dealer.
- If the unit shuts down again, call your WaterFurnace dealer as soon as possible. Do not repeatedly reset your unit.

What if my unit does not operate properly?

Before you call your WaterFurnace dealer for service, check these service hints:

- Check air filters. Depending upon filter type, clean or replace if necessary. (See below.)
- Make sure the thermostat is set properly.
- Check to make sure the electrical disconnect switches are in the ON position. Both the unit and auxiliary heat (if present) must be powered for proper operation.
- Check for a tripped circuit breaker or a blown fuse in your home or building's main power box. Reset breaker or replace fuse.
- If either the disconnect switch or the circuit breaker continues to trip after you reset it, call your WaterFurnace dealer immediately to prevent damage to your unit.
- Check the thermostat indicator lights to ensure proper operation of the system.
- Check the unit status lights on the front of the unit to ensure the unit is operating properly.
- If you can't determine the problem, call your WaterFurnace dealer promptly.

What is a "lock out"?

A lock out occurs when the unit has faulted and cannot correct itself. This mode protects the unit from further damage. During lock out mode, Emergency Heat will be activated to provide heating if necessary.

What about air filters?

One of the most important things you can do to ensure long system life, high performance and clean indoor air is to keep the air filter clean. For filters with disposable media, discard the filter when it is dirty and replace it with a new clean filter. Never attempt to re-use a disposable filter by cleaning it or placing it in backwards. Electronic filters have a replaceable media. Electrostatic filters are "permanent" and can be easily washed. Never run the unit without a filter.

The frequency in which you should clean or replace your filter is dependent upon several variables including the type of filter media, your outdoor environment and your indoor environment. Families with lots of activities, pets or with people sensitive to allergies should clean/replace filters more often. Contact your dealer with a recommended schedule for filter maintenance.

If you have opted for a permanent electrostatic filter, wash it with a garden hose and a *mild* household cleaner at least every 60 days. When placing the filter back in the slot, be sure that the filter is dry and that the arrow on the filter frame points toward the unit. (See page 45 for more information.)

If you have an electronic air cleaner installed, check with your dealer or refer to the air cleaner's owner's manual for cleaning instructions. (See page 44 for more information.)

Filter Access



How do I unclog the drain pan?

In the cooling mode, moisture removed from the air forms as condensation on the air coil and the resulting water runs down to the condensate drain pan. The drain can pick up lint and dirt, especially with dirty air filters. If overflow occurs, the DRAIN light will come on (in units equipped with status lights) and the system will shut down. If the water does not run freely, clean the drain pipe. Dilute a capful of chlorine bleach in a quart of water and pour the solution in the drain pan once a year. This helps to prevent algae.

To gain access to the drain pan for inspection or cleaning:

1. Turn off all power to unit and auxiliary heat.
2. Remove the screws holding the fan compartment door closed.
3. Lift the door up and pull out at the bottom.

Drain Pan



Note: The drain pan is the black plastic or metal rectangular pan with the drain hole in the middle, under the air coil.

If my system includes an Auxiliary Heater, what does it do and why was it used?

Your system may include an Auxiliary Heater (mounted either internally or externally depending on the model) which is used for two purposes:

- To supply back-up heat during cold outdoor temperatures
- To provide emergency heat if the unit's compressor fails

Generally, dealers will size the geothermal unit to provide the majority of the heating requirements down to a certain outdoor air temperature. When conditions exist that require more capacity than the geothermal unit is sized to deliver, the auxiliary heater engages to assist the geothermal unit (which continues to work). If the unit were to be sized to provide 100% of the heat on the coldest day, the unit would be "oversized" every day that isn't the coldest day of the year. Plus, the initial cost of installation could have been significantly more for a larger unit and additional loop. Your dealer has determined the right combination/size of equipment that makes economic sense in terms of installation cost and operating cost.

The other reason for the Auxiliary Heater is to provide heating in the event of a compressor failure. Switching to Emergency Heat mode on your thermostat will provide the home with a source of heat until the compressor is replaced.

Does my unit heat water?

Some units are equipped with a "hot water assist" component. This component preheats water by raising the temperature 5° - 10° F and then delivers it to your water heater using a small pump. The "hot water assist" is not designed to heat water like your water heater. However, a unit equipped with a "hot water assist" heats water much more *efficiently* than your water heater to provide energy savings whenever the unit is heating or cooling. The amount of hot water generated by the "hot water assist" is a function of how long the unit is running and in what mode it is in. With the "hot water assist", more water is heated in the cooling mode than in the heating mode. *For more information, see page 41.*

What if I run out of hot water?

Units equipped with hot water generators provide only *supplemental* water heating. Your water heater will operate if the unit is not heating the water enough. This will ensure that you have an adequate supply of hot water. If you run out of hot water, it is most likely a problem with the water heater and not the geothermal unit.

How do I know where my earth loop is located?

Earth loops can be installed in several configurations depending on the space available. The company who installed your loop should provide you with a layout of the loop field, with measurements & locations of each circuit length based on fixed locations (e.g. the corners of the house). Some loop contractors install metallic tape or tracer wire in the trench to assist in future locating. Keep this document, and refer to it before doing any digging or excavating in the area of the loop. It is also recommended that you sketch out the loop location onto the grid on page 13.

Is maintenance required for the earth loop?

No regular maintenance is required. However, if you notice air noise within the piping or if your loop is ever damaged by excavation, contact your WaterFurnace dealer.

Should I use the Continuous Fan mode?

In Continuous Fan mode, your blower operates constantly, even when the unit is not heating or cooling. The Continuous Fan mode (selected on your thermostat) can reduce hot spots or cold spots throughout the home by constantly mixing the air. Indoor air quality is also improved due to continuous filtration. Using Continuous Fan mode in units equipped with ECM blowers is very inexpensive. However, using Continuous Fan mode in units equipped with PSC blowers is considerably more expensive and will noticeably increase operating costs.

What about units using well water?

An adequate water supply to the unit is very important. Do not let anyone disrupt the water supply by rerouting the supply line or tapping into it without first checking with your WaterFurnace dealer. If the well pumping system requires service or is inoperable, your unit should be turned off or placed into emergency heat until an adequate water supply is restored.

Depending on the water quality, some maintenance is usually required with a well water system. Because of minerals and other particles in the water, without a routine of preventive maintenance, this material may eventually begin to clog the heat exchanger in the unit. When this happens, the efficiency and capacity of the unit is decreased, eventually to the point where failure may occur.

To minimize the potential of this happening, a heat exchanger cleaning schedule should be established with your dealer. The frequency will depend on the specific quality of your well water. Some homeowners find that they can go a few years between cleanings; others may need to have the heat exchanger cleaned yearly. In order to achieve optimum performance, energy savings and long system life, it is necessary to have your dealer perform this service as needed. Remember-- preventive maintenance is less expensive than replacing major components.

The cleaning procedure requires special equipment and chemicals. Therefore, do not attempt to clean the heat exchanger yourself.

Why does the unit run more/longer than a gas furnace?

The amount or percentage of time that your unit is actually heating or cooling is called Run Time. To achieve maximum comfort during heating, geothermal systems will typically have a longer run time than a natural gas or propane furnace. That's because geothermal systems will deliver a more moderate air temperature instead of the hot blast of air from a gas furnace.

Fossil fuel forced air heating systems will typically have short run times—a lot of high temperature air for a few minutes, followed by a cooling off period, then another blast of hot air, and on and on. This type of operation results in ever-changing indoor temperatures and hot/cold spots within the home. This frequent cycling causes wear and tear on a gas furnace.

Your geothermal system will most likely run for longer periods of time than a gas furnace. It's designed to do just that. You'll get improved comfort and minimize hot/cold spots. And these longer run hours actually help to increase efficiency and reduce wear and tear associated with frequent starting and stopping. It's like driving your car in the city vs. the highway. The frequent starting and stopping of city driving causes more wear and tear than highway driving. And you achieve more miles per gallon (better efficiency) on the highway with fewer stops and starts. The same principle holds true with your geothermal system.

How is the unit sized for my home?

Your system has been designed to meet the heating and cooling requirements of your home based on your local weather. Each home is different, so calculations are performed to ensure that the unit size is the optimum selection. These calculations are based on square footage, insulation, windows, doors, infiltration, outdoor weather extremes, and many other factors. If the unit were undersized and unable to meet the heating requirements on a very cold day, you would notice a drop in indoor temperature. In addition, the unit would consume more energy than is necessary. If the unit were undersized and unable to meet the cooling requirements on a very hot day, you would notice that the indoor temperature may not ever reach the setpoint on the thermostat. Conversely, units that are oversized with too much capacity may result in short cycle times which may adversely affect comfort in both heating and cooling. Oversized units would result in poor dehumidification during cooling.

Heating systems are measured by BTU capacity per hour. Cooling systems are measured by "Tons" (which is also BTU capacity). One BTU is the amount of energy required to raise 1 lb. of water 1 degree F—it's roughly equivalent to the amount of heat given off by a wooden kitchen match burned end to end. In air conditioning terms, a "ton" is 12,000 BTUs/hr.

Should I close off a register in an unused room?

Some homeowners have unused rooms that may not require heating or cooling like the rest of the home. While there is often a tendency to close registers in an unused room, the effects may actually reduce comfort without saving any money in operating costs. The home's duct system has been designed to deliver the right amount of air into the various spaces. Closing off one or more registers disrupts the air flow pattern, creates an unbalanced system and may in fact, be detrimental to the comfort levels experienced in the other rooms. In addition, the desired energy savings may not be achieved.

If you have larger areas or multiple rooms that do not require continuous heating and cooling, you may want to consider a Zone Control System. These systems use several thermostats throughout the home, and have motorized dampers electronically controlled to deliver properly balanced air flow and provide desired temperatures and comfort throughout the various zones. WaterFurnace offers an exclusive IntelliZone system. For more information on zone control systems, see page 50 and contact your WaterFurnace dealer.

What about remodeling & room additions?

Because your system has been selected, designed and installed based on the existing heating and cooling requirements of your home, a significant change or addition to the home may result in the system being inadequately sized. If you are planning any remodeling that might affect the heating/cooling requirements, including adding more rooms, windows, or exterior doors, consult with your dealer to determine if the existing system is adequate. Depending on the extent of your changes, your existing unit may be adequate or you may have to install a larger unit or install an additional unit. Installing a larger unit or an additional unit will require more duct work and may also result in the need to add more loop in the ground.

What about adjusting the thermostat when entertaining many people?

The temperature in your home can be affected significantly by the number of people inside. Our bodies generate heat through metabolism—in fact, your body gives off about 300 – 400 BTUs per hour. This number can double or even triple at high activity levels (dancing, sports, etc.) Many homeowners find that when entertaining large numbers of people in the home, the temperature may rise noticeably due to the number of people “generating” heat and the heat given off by using many lights and other appliances (TVs, stereos, cooking devices, etc.)

As a result, you may find a need to air condition even though it may be cold outside. If your thermostat has an automatic changeover feature, ensure that the cooling setpoint will be a comfortable setting for your guests. If you have a manual changeover thermostat or if your thermostat is set for heating only, you should be prepared to change it over to cooling when you have many people inside the home, even when it's cold outside. Another suggestion is to set the fan for continuous “on” so that the air is fully circulated throughout the various rooms to minimize hot spots or cold spots. When the guests leave, and occupancy levels return to “normal”, be sure to switch back to heating mode if it's cold outside. In the summer, you could benefit by setting the cooling setpoint a little lower than normal prior to many guests arriving so that the system can adequately maintain the temperature inside with the additional people and high outdoor temperatures.

Depending on a combination of factors (unit capacity, number of people, activity levels, and outdoor temperature) you may experience some fluctuation in indoor temperature; this is normal and only temporary.

And don't worry about energy costs when doing some “extra” cooling. If your unit is equipped with a desuperheater, the heat removed from the house during cooling is going into your water heater.

What about humidity control?

Geothermal units do an excellent job of removing humidity during cooling. This results in better comfort. However, during heating (depending on your home and outdoor air temperatures) you may experience the effects of having too little humidity indoors. This is not the fault of the unit—it does not remove any humidity during heating (unlike a gas furnace). In the event that your home does not maintain optimum indoor humidity levels of 40-50% relative humidity during the heating season, you may benefit from using a whole house humidifier integrated into your system. Contact your dealer and refer to page 43 for more information.

Should the duct work be cleaned?

Ducted HVAC systems can be a collection point for a variety of contaminants (mold, fungi, bacteria and dust) that have the potential to adversely affect your health. In addition to improved indoor air quality and the possible health benefits of duct cleaning, the EPA has demonstrated that HVAC systems run more efficiently when these contaminants are removed from the system. Older homes, or homes with smokers, pets, and people sensitive to allergies could benefit from duct cleaning. Many HVAC contractors can perform an inspection and duct cleaning using specialized equipment. Contact your dealer for more information.

Can the air in the home be “sanitized” in any way?

Indoor air quality can be improved using special ultra-violet (UVC) lights placed in the air distribution system. Although these lights do not remove any contaminants (you’ll still need a filter) they will kill (or render sterile) airborne or surface microorganisms including bacteria, germs, mold spores, and pollens. In addition to the health benefits of this technology, equipment efficiency can be improved by the fact that the air coil is kept cleaner. Contact your dealer for more information.

What is ENERGY STAR®?

ENERGY STAR® is a program supported by the U.S. Dept. of Energy and the EPA, designed to help homeowners and businesses protect the environment using superior energy efficient technologies. Nationwide, the annual savings using ENERGY STAR® products is equal to the amount of energy required to power 20 million homes, and avoid greenhouse gas emissions equivalent to 18 million cars. This represents billions of dollars in savings.



Energy efficient choices for the home can save you up to one third of your energy bill without sacrificing features, style or comfort. When considering new household appliances, consider ones that have earned the ENERGY STAR® rating. They meet strict efficiency guidelines established by the government. In addition to appliances, whole homes can be constructed with ENERGY STAR® standards built right in. For more information on ENERGY STAR®, go to www.energystar.gov.

Is my unit ENERGY STAR® rated?

Our highest efficiency units meet ENERGY STAR® standards. These include:

- Envision Series, Envision Series Splits, Envision Series Air Handlers
- Synergy3D
- Premier, Premier Splits
- E Series

ENERGY SAVING TIPS

Now that you've invested in the most energy efficient heating and cooling system available, here are some additional tips to help you save money on your energy costs throughout your entire home.

Fluorescent Lights

Fluorescent lights use a fraction of the amount of energy as incandescent bulbs. Consider replacing your highest usage incandescent bulbs with fluorescent ones.

Consider ENERGY STAR® Appliances

In addition to your highly efficient geothermal system, you may want to consider other household appliances that meet the ENERGY STAR® standards. ENERGY STAR® options are available for refrigerators, clothes washers, ceiling fans, dishwashers, home audio systems, TVs, computer equipment, etc. A listing of ENERGY STAR® appliances can be found at www.energystar.gov.

Duct Sealing and Insulation

A recent study revealed that a large percentage of homes had at least one section of duct disconnected somewhere in the system (without the homeowner knowing about it). Regardless of the heating & cooling system type installed, having properly connected and sealed duct work is critical to proper performance. Despite its name, duct tape is generally insufficient to seal leaks in a duct system. Over time, the adhesive used on duct tape will dry out resulting in tape failure. Other tape types and sealants used by professional HVAC contractors are better suited for sealing duct systems. It is also recommended that the duct work be insulated (either internally or externally) when it is located in an unheated or uncooled area (attic, crawl space, etc.)

Insulation, Weather Stripping and Sealing

Ensure that your home has the suggested levels of insulation. The amount of insulation required depends on the type of insulation and your climate. Adequate weather stripping and sealing around windows, doors, and electrical outlets can have a dramatic effect on air moving from outside to inside (infiltration) and on air moving from inside to outside (exfiltration).

Water Heater Blankets

Most water heaters can benefit from adding a special insulating blanket around the tank. These are inexpensive and available at most hardware stores, and are easy to install. Water heaters placed directly on concrete floors dissipate heat into the concrete adding operating cost.

Replacement Windows

If you have old leaky windows, consider replacing them with high efficiency models. Today's premium windows are very energy efficient, and some contain coatings or gasses that reduce harmful ultraviolet rays and reduce your cooling requirements. Consider ENERGY STAR® models.

PRODUCT INFORMATION FOR UNITS, OPTIONS & ACCESSORIES

The following section (pages 32 to 50) includes specific information on our various WaterFurnace geothermal units, options and major accessories.

Because of the wide variety of products that we have available, and the fact that geothermal units are different than ordinary heating and cooling systems you have experienced, the information provided here will help you to better understand the specific features of your unit. We have also included information on major options and accessories - how they work and why you may want to consider adding other accessories that you may not currently have.

Regardless of which unit has been installed in your home, we're confident that you'll be like the hundreds of thousands of other geothermal system owners all over the world who enjoy the performance of this exceptional system.

Model Number/Serial Number Reference

WaterFurnace manufactures a variety of models of geothermal units. The various models have unique model numbers which can be located on the unit's Data Plate. The data plate is usually placed on the front or side of the unit.

The model number contains 11 to 15 letters and numbers.

The unit's serial number can also be found on the data plate. Serial numbers consist of nine numbers or two letters followed by four numbers, all of which indicate by code, the date your unit was built.

Locate the data plate on your unit and record the model number and serial number on the inside front cover of this Owner's Manual for future reference.

You can identify the type of unit you have by the unit emblem or the model number and a few other identifying characteristics. There are five "families" of units in our product line, and within each family are one or more models. The five families of units are:

- Envision
- E Series
- Premier
- Synergy3D
- Versatec



If your unit has a model number starting with "N", you have an Envision Series unit. Envision Series units are available in "ND", "NS", "NDZ" and "NDS" models. Standard Envision Series units are self-contained "package" units in either vertical or horizontal cabinets. NDS and NDZ units are "splits", and are connected to a separate indoor air handler or gas furnace.

If your unit has a model number starting with "P", you have a Premier Series unit. Premier units are available as "package" units in both vertical and horizontal cabinets. If the first letter in the model number is "P" and the fourth digit is "D", you have a Premier "Split" unit. Splits are connected to a separate indoor air handler or gas furnace.

If your unit has a model number starting with "SDV", you have a Synergy3D unit.

If your unit has a model number starting with "V", you have a Versatec unit.

If your unit has a model number starting with "EW", you have an E Series hydronic (water based) unit.

MODEL: 		E035TR111NBDSSA	
S/N : 		UJ1087	
W.O.#: 150218			
UNIT VOLTAGE		HZ	PH
208/230		60	1
		FLA	
		22	
MINIMUM	MAX FUSE	MAX HACR	MAX BRKR
CIRCUIT AMP	TIME DELAY	BRKR (USA)	CANADA
25	35	35	35
COMPRESSOR	MOTOR	Vac	PH
		FLA	HP
Vac 208/230	BLOWER	208/230	1
			4
PH 1	LOOP PUMP	208/230	1
			5.4
RLA 12.2	DSH PUMP	208/230	1
			0.4
LRA 66.0			
QTY 1			
CK	HEATER	SUPPLY	KW
BOX	MODEL	CIRCUIT	
[]	EAM(H)5	SNGLE	3.6/4.8
[]	EAM(H)8	SNGLE	5.7/7.6
[]	EAM(H)10	SNGLE	7.2/9.6
			MIN CIR
			AMP
			MAX FUSE
			MAX BRKR
			30/30
			40/45
			50/60
MARK HEATER INSTALLED WITH "X" IN CHECK BOX. FOR ACTUAL HEATER RATING, SEE MARKING INSIDE OF UNIT.		COCHER "X" POUR INDiquer LE MODELE INSTALLE POUR LES CARACTERISTIQUES NOMINALES DES UNITES DE CHAUFFE VOIR LE MARQUAGE A L'INTERIEUR	
MIN/MAX VOLTS		197/253	REFRIGERANT
MAX E.S.P.		0.5	FACTORY CHARGE (OZ)
MAX OUTPUT AIR		200 F	R410A
COMBUSTIBLE CLEARANCE (IN)		DESIGN PSI	
UNIT	DUCT	FT	HI SIDE
0	AND 0	FOR 0	450
			LO SIDE
			240
Comments: R410A REFRIGERANT BRISTOL COMPRESSOR			
Manufactured: Fort Wayne, Indiana USA			

Envision Series Units



As our latest flagship product, WaterFurnace Envision Series units have set a new industry standard for efficiency and performance. Envision Series units utilize the ozone-safe R-410A refrigerant to meet the most stringent EPA requirements, efficient compressors, quality components, sophisticated controls and many other features to provide reliable and efficient operation.

Envision units feature Scroll compressors. Unlike reciprocating compressors that use a piston, a scroll compressor uses a rotating spiral inside a stationary spiral. During operation, the rotating spiral moves in a single direction instead of an in an up-down/start-stop fashion like a reciprocating compressor. Scroll compressors have proven to be very dependable, quiet and efficient. Depending on the size of your Envision unit, you may have either a single speed Scroll compressor or a dual capacity Scroll compressor. The dual capacity Scroll compressor has the ability to operate in either high capacity or low capacity operation using an additional set of ports. Low capacity operation is approximately 2/3rds of full capacity operation. The thermostat communicates with the microprocessor control in the unit which determines whether operation is in low or high. The unit always starts in low. Changing from low to high happens automatically and without any interruption in operation. Single speed Envision units are sizes 022, 030, 036, 042, 048, 060 and 070. Dual capacity Envision units are sizes 026, 038, 049, 064, and 072.

Envision units include variable speed ECM blower motors. Multiple fan speeds can be selected by the dealer to provide the right amount of airflow for your installation. In addition, the ECM motor will automatically speed up or slow down depending on the mode or stage of operation. The unit has the ability to operate in a special “dehumidification” mode during cooling. In the event that the desired temperature is reached before adequate dehumidification is achieved in cooling, you may benefit from operating in this mode. Contact your dealer if you experience this condition.

A sophisticated microprocessor control sequences all components during operation for optimum performance with the ability to signal various fault conditions (see page 24). The microprocessor also provides easy-to-use troubleshooting features and on-board diagnostics for your dealer to quickly identify and resolve service issues. Safety features include high- and low-pressure refrigerant controls to protect the compressor, low source water temperature limit, and fan start detection. In the unlikely event of a compressor failure, the emergency heat is enabled to satisfy heating requirements. Another sensor detects if the condensate drain pan is full, at which time the unit will be shut down for protection against water leaks (see page 24). In units equipped with hot water assist, hot water temperatures are monitored to ensure that dangerous limits are not reached.

Operation and reliability is further enhanced by a ComfortAlert control module which monitors compressor functions and assists in troubleshooting.

Product durability features include heavy-gauge metal cabinets which are coated with durable poly paint for long lasting protection. Envision Series units include coated air coils for long life and corrosion resistance.

These units are performance-certified to ARI ISO 13256-1 standards, are ETL safety listed, and are ENERGY STAR® qualified.

Envision Series Air Handler



The Envision Air Handler is a high-efficiency air handler that carries the Waterfurnace name to complement our industry-leading Envision Split Series and EW units.

The Envision Air Handler is available in 2 to 5 ton capacities with a refrigerant/hydronic coil option that allows it to be compatible with the 2 to 6 ton Envision Splits, or the 2 to 6 ton EW units. The air handler comes standard with a variable speed (ECM) motor for maximum comfort and savings. Optional internal electric heat is also available and can be either factory or field installed

The Envision Air Handler air coils in the refrigerant models are designed for ozone-safe R-410A refrigerant. Configured as an 'A' coil, rifflled copper tubes and enhanced corrugated lanced aluminum fins that provide high efficiencies at low face velocities. Both the refrigerant and hydronic coils have the exclusive FormiShield™ coating for added protection.

The air handler's cabinet is constructed of heavy gauge environmentally-responsible galvanized steel for maximum corrosion resistance. All units are painted with a silver metallic powder coat finish. All interior surfaces are lined with ½" thick, foil lined acoustic type fiber insulation, applied in a manner that prevents the introduction of glass fibers into the air stream. The narrow cabinets are shipped in one piece but can be separated into two pieces for ease of installation in tight places such

as attics, and a field adjustable, four position design also allows for horizontal, vertical, and bottom flow right/left configurations.

Other features include a blower assembly that can slide in and out for ease of conversion in the field, and an ECM interface board that allows for fan speed selection and thermostats inputs. The Envision Air Handler also comes standard with a factory-installed TXV with internal check valve located inside the cabinet; a 1" filter rack, and two corrosion proof stainless steel drain pans. One for vertical and one for horizontal applications-both have dual drain connections.

Envision Air Handler units are performance-certified to ARI ISO 13256-1 standards, are ETL safety listed, and are ENERGY STAR® qualified.

Because Envision Air Handlers are used in conjunction with other Envision Series units or other manufactures heat pumps, refer to the documents included with those units for further operating and service information.

Envision Series Outdoor Split Units



Envision Series Outdoor Splits are designed for either indoor or outdoor installations, and offer exceptional flexibility for both replacement and new construction applications. The term “split” refers to the fact that there are actually two pieces of equipment in the system. Whether it’s installed indoors or outside, the Envision geothermal unit (compressor section) is connected to an air handler or fossil fuel (gas, propane or oil) furnace. This allows the Envision unit to be located some distance away from the actual blower section.

The unit will provide all the air conditioning requirements and a portion of the heating load down to a pre-determined temperature. When connected to a fossil fuel furnace, the geothermal unit disengages when outdoor temperatures fall below the change-

over point, allowing the fossil furnace to provide the balance of the heating required. If the split is connected to a standard air handler, the use of auxiliary electric (back-up heat) may be needed at outdoor temperatures lower than the changeover point, but the geothermal unit will continue operating.

The compressor in the unit is a dual capacity scroll. This series is available in sizes 026, 038, 049, 064, and 072. The dual capacity scroll compressor has the ability to operate in either high capacity or low capacity operation using an additional set of ports. Low capacity operation is approximately 2/3 of full capacity operation. The thermostat communicates with the microprocessor control in the unit which determines whether operation is in low or high. The unit always starts in low. Changing from low to high happens automatically and without any interruption in operation. If the connected air handler or furnace is equipped with a variable speed blower, you may notice the fan speed change depending on the mode of operation.

A sophisticated microprocessor control sequences all components during operation for optimum performance. This control also facilitates troubleshooting for the service technician. The unit’s heat exchanger has an optional copper-nickel alloy to resist corrosion.

The cabinet is finished with poly paint for long lasting beauty and protection, adding to the durability of the unit when it’s installed outside. Where there is a need to conceal the unit outdoors, or to add an aesthetic touch, an optional decorative rock cover is available in three colors (brown granite, gray granite, and charcoal basalt). See your dealer for details on this option.

Envision Series Outdoor Split units are performance-certified to ARI ISO 13256-1 standards, are ETL safety listed, and are ENERGY STAR® qualified. Like all other Envision Series products, the Envision Series Outdoor Split units utilize the ozone-safe R-410A refrigerant.





Because outdoor split units are used in conjunction with Envision Series Air Handlers or fossil fuel furnaces, refer to the documents included with those units for further operating and service information.

EW Series Units



EW Series Hydronic units can be used in a variety of applications including domestic hot water, radiant floor heating, pool/spa heating, and even snow melt. Also, when combined with the Envision Series Hydronic Air Handler, the EW Series units can provide for the heating and cooling of the air

A sophisticated microprocessor controls the pumps and compressor by sampling water temperatures even during “off” cycles. The controller enables the user to view all modes of operation and easily adjust setpoint temperatures. This control has a wide range of set-up flexibility to meet the variety of applications in which the unit can be installed. However, configuration of the control is done only at the time of installation as it requires special codes and a thorough understanding of the application and the control sequence.

Generally, the unit will be set and controlled automatically to provide the correct temperature water. However, you can view the setpoint, by pressing the  or  arrow once (the display on the control panel will begin flashing). Subsequent presses of either the  or  arrow will change the setpoint by one degree.

In addition to the water temperature display, the control panel also has 6 LED indicators that indicate when the unit is in one of the following modes: Lockout, Standby, Primary, Heating, Cooling, or Secondary Mode. To change modes, press the

mode button.

To protect the unit, the control monitors functions and conditions within the system. In the event of a failure or unsafe condition, the unit will go into Lockout mode. During lockout mode, the display will flash the lockout code corresponding to the fault condition. The compressor, pumps, and secondary output are de-energized. Lockout modes of any kind can be reset by pressing the mode button twice. Turning off the unit’s breaker (and then back on after 60 seconds) also resets the lockout. Do not repeatedly reset the lockout. Doing so could damage the unit or other components in the system. Contact your dealer to resolve the problem.

EW units include Scroll compressors and R-410A refrigerant for exceptional efficiency and performance. These units are ENERGY STAR® qualified and safety certified by ETL.

 **Premier Units**



Premier Series products changed the standards for efficiency and revolutionized the industry when the company first introduced the product line. Today, with over a decade of continuous improvements and upgrades, the Premier line has earned a reputation for quality, efficiency and reliability.

Premier products feature Scroll compressors (except sizes 010 and 013). Units are available with variable speed ECM blower motors or the standard single speed PSC blower. In units equipped with variable speed blowers, you may notice the fan speed changing automatically depending on the mode of operation.

A sophisticated microprocessor control sequences all components during operation for optimum performance with the ability to signal various fault conditions (see page 24). The microprocessor also provides easy-to-use troubleshooting features and on-board diagnostics for your dealer to quickly identify and resolve service issues. Safety features include

high- and low-pressure refrigerant controls to protect the compressor, freeze protection, and fan start detection. In the unlikely event of a compressor failure, the emergency heat is enabled to satisfy heating requirements. Another sensor detects if the condensate drain pan is full, at which time the unit will be shut down for protection against water leaks (see page 24). In units equipped with hot water assist, hot water temperatures are monitored to ensure that dangerous limits are not reached.

Premier Series units equipped with variable speed ECM blowers have the ability to operate in a special “dehumidification” mode during cooling. In the event that the desired temperature is reached before adequate dehumidification is achieved while cooling, you may benefit from operating in this mode. Contact your dealer if you experience this condition.

Product durability features include heavy-gauge metal cabinets which are coated with durable poly paint for long lasting protection. Premier Series units include coated air coils for long life and cupronickel coaxial heat exchangers for added corrosion resistance.

These units are performance-certified to ARI ISO 13256-1 standards, are ETL safety listed, and are ENERGY STAR® qualified.

Envision and Premier Split Units



Envision and Premier Series splits offer exceptional flexibility for both replacement and new construction applications. The term “split” refers to the fact that there are actually two pieces of equipment in the system. The geothermal unit (compressor section) is connected to an air handler or fossil fuel (gas, propane or oil) furnace. This allows the split unit to be located some distance away from the actual blower section.

The unit will provide all the air conditioning requirements and a portion of the heating load down to a pre-determined temperature. When connected to a fossil fuel furnace, the geothermal unit disengages when outdoor temperatures fall below the changeover point, allowing the fossil furnace to provide the balance of the heating required. If the split is connected to a standard air handler, the use of auxiliary electric (back-up heat) may be needed at outdoor temperatures lower than the changeover point, but the geothermal unit will continue operating. If the connected air handler or furnace is equipped with a variable speed blower, you may notice the fan speed change depending on the mode of operation.

Envision Series Splits — include single speed compressors (sizes 022, 030, 036, 042, 048, 060, 070) or Dual Capacity scroll compressors (sizes 026, 038, 049, 064, 072). Dual capacity compressors have the ability to operate in both low and high stage, depending on the heating and cooling requirements. In the event that the first stage of operation (part capacity) does not satisfy the thermostat, the unit will automatically change to second stage (full capacity) compressor operation. If the connected air handler or furnace is equipped with a variable speed blower, you may notice the fan speed change depending on the mode of operation. A sophisticated microprocessor control sequences all components during operation for optimum performance. This control also facilitates troubleshooting for the service technician. Externally-mounted status lights indicate to the homeowner or the service technician either normal operation or the nature of a fault. Envision Series Split units utilize R-410A refrigerant.

Operation and reliability is further enhanced by a ComfortAlert control module which monitors compressor functions and assists in troubleshooting.

Premier Splits— All Premier splits feature reliable and efficient Scroll compressors. With standard electromechanical controls, Premier split units are easy to troubleshoot and repair. Safety devices prevent operation when conditions exist that would damage the unit. If the heating and cooling functions are inoperable, you may be able to reset the unit by turning off the unit’s breaker for 60 seconds, then turning it back on. If the unit does not operate after resetting, do not attempt another reset as doing so may damage the unit or components. Contact your dealer for service. Like our other Premier series products, Premier split units utilize R-22 refrigerant.

WaterFurnace splits are performance-certified to ARI ISO 13256-1 standards, are ETL safety listed, and are ENERGY STAR® qualified.

Because indoor split units are used in conjunction with Envision Series Air Handlers or fossil fuel furnaces, refer to the documents included with those units for further operation and service information.

 **Synergy3D Units**



With the Synergy3D Series, you'll enjoy incredible energy savings on your heating and cooling costs while providing hot water for radiant floor heat. The Synergy3D is the geothermal equivalent of a boiler, furnace and air conditioner—all in a single unit. Units are available in four vertical sizes. Heavy-gauge metal cabinets are coated with a durable metallic finish for long lasting beauty and protection. Copeland dual capacity scroll compressors provide outstanding performance and reliability, while coated air coils add durability and longer life. Synergy3D units utilize ozone-safe R-410A refrigerant. Variable speed ECM blower motors are used for quiet operation. A sophisticated microprocessor control sequences all components during operation for optimum performance, and provides easy-to-use troubleshooting features with fault lights and on-board diagnostics. To help achieve ultimate comfort, heating priority may be given to forced air zones or radiant floor heat.

The Synergy3D was designed to combine the comfort of radiant heat and the efficiencies of forced air. Whether you choose to use radiant heat in small zones like bathrooms and the kitchen, or in larger zones like the basement floor, the Synergy3D delivers. Use in combination with our WaterFurnace GeoTank. The GeoTank is simply the best way to capture preheated water from your unit. Engineered specifically for your WaterFurnace geothermal system, the GeoTank includes unique features that make installation and operation easy.

Synergy3D units are performance-certified to ARI ISO 13256-1 standards, are ETL safety listed, and ENERGY STAR® qualified.

Versatec Series Units



Versatec Series products are an excellent choice where versatility and compact size are important considerations.

Units include reciprocating compressors, R-22 refrigerant and PSC blower motors. With PSC blowers, units operate with only one fan speed regardless of the mode of operation. However, the fan speed can be adjusted internally by your dealer.

With standard electromechanical controls, Versatec units are easy to troubleshoot and repair. Safety devices prevent operation when conditions exist that would damage the unit. If the heating and cooling functions are inoperable, you may be able to reset the unit by turning off the unit's breaker for 60 seconds, then turning it back on. If the unit does not operate after resetting, do not attempt another reset as doing so may damage the unit or components. Contact your dealer for service.

In northern climates, Versatec units may include an optional duct mounted auxiliary heater. In the unlikely event of a compressor failure, the auxiliary heater will provide emergency heat to maintain temperatures within the home. If your thermostat is set to a normal heating mode, and you see an Emergency Heat signal on your thermostat, contact your dealer. This same auxiliary heater may be used during cold outdoor air temperatures to assist the Versatec unit in maintaining warm indoor temperatures. This is a normal function, and your geothermal unit will continue to operate. Depending on your thermostat, you may see an Auxiliary Heat signal during this time. Your dealer can tell you the approximate outdoor temperature when the auxiliary heat may be activated. For more information on auxiliary heat, see page 42.

Versatec Series units are performance-certified to ARI ISO 13256-1 standards, and are ETL safety listed.

Optional Hot Water Assist

Many geothermal units installed in homes have an optional feature called a hot water generator or desuperheater. This component consists of a refrigerant-to-water heat exchanger installed at the discharge of the compressor. The hot gas at this point is in a “superheated” condition. In the desuperheater, the refrigerant releases some of the heat into the cooler water through the copper wall of the desuperheater heat exchanger. A small circulator moves the water from the water heater to the heat pump and back to the water heater.

This excess hot gas is available in both the heating and cooling modes. However, there is a greater hot water benefit during cooling because some of the heat that is extracted from the air ends up in the superheat, and is transferred to the water. When operating in second stage heating, some units disable the circulator so that all the heat energy is devoted to the air.

It is important to note that the Hot Water Assist function simply *assists* in *preheating* water. The temperature rise through the unit is generally 5 -10° F.

The amount of hot water generated is a function of the model and run time of the unit. On very hot days and cold days, the desuperheater could generate more hot water required for the home due to the long run times of the unit. On milder days when the unit has short duty cycles, the electric elements in the water heater will maintain the desired temperature so there will always be enough hot water for the homeowner.

Some installations use a single tank for storage of hot water. Other installations use two tanks to provide extra hot water capacity with added efficiency.

A safety device (sensor) shuts off the circulator for the desuperheater in the event that the water temperature reaches 130° F (54° C). The yellow status light will be illuminated. At this time your unit’s hot water pump will be de-energized to prevent excessive temperatures. Don’t worry; hot water operation will automatically resume when the tank cools off. This is not a fault condition, and the unit does not require resetting.

A switch located below the status lights, enables you to manually turn off the internal desuperheater pump. When this switch is off, your unit’s hot water pump is manually disabled, and DHW OFF status light will be lit. This switch may be used when the water heater is being serviced or replaced. This switch must be turned off when water flow from the water heater to the unit is turned off or disconnected. Damage to the pump may otherwise occur.

Auxiliary Heater

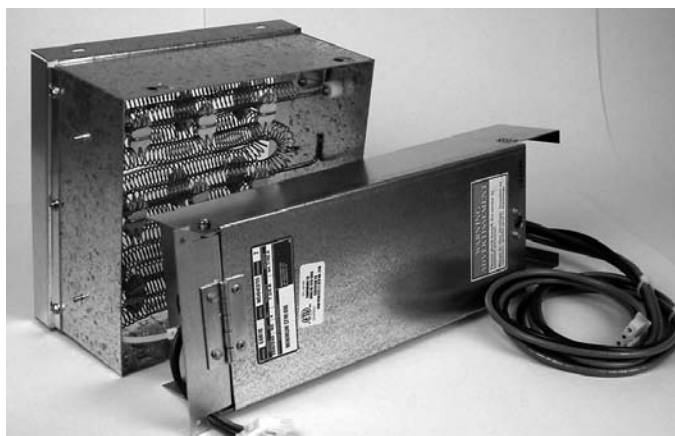

Most installations in northern climates include an Auxiliary Heater (mounted either internally or externally depending on the model). Auxiliary heaters are used for two purposes:

- To supply back-up heat during cold outdoor temperatures
- To provide emergency heat if the unit's compressor fails

Back-up Heat

Your geothermal unit will provide the largest majority of your heating. The amount of heat provided by the auxiliary heater will vary from house to house depending on factors like climate, unit sizing, heating load, and economics.

Economically, there is a point (outdoor air temperature) where it makes sense for the geothermal unit to work in conjunction with the auxiliary heat. When considering both the cost of installation and the cost of operation, it often makes sense to size the geothermal unit to provide something less than 100% of the total heating requirement. Generally, sizing the unit in a northern climate to provide 100% of the heating does not make sense economically because the added initial cost of the larger unit and earth loop may not be recovered in energy savings over a reasonable period of time.

For example:

Installation Option A: The geothermal unit is sized to provide 95% of your heating requirement with the other 5% using the auxiliary electric.

Installation Option B: The geothermal unit is sized to provide 100% of the heating load.

Assume the cost to operate the auxiliary heat (in Option A) is \$50 per year. And the additional cost of the larger system (Option B) is \$2,000 more.

So, dividing \$50 (savings) into \$2,000 (additional investment) yields a 40-year return on investment. You can easily see why it makes sense to size the system to allow auxiliary electric to provide some of the heating requirement.

Oversizing the unit may not be cost effective, and it can also lead to decreased comfort and additional wear and tear on your unit. Units that run for very short periods of time actually incur more stress on the compressor than units that run for longer periods.

WaterFurnace dealers are trained and have the design tools to determine the most effective size system for your home considering performance, comfort, installation cost and operating cost.

Emergency Heat

The other reason for the Auxiliary Heater is to provide heating in the event of a compressor failure. Switching to Emergency Heat mode on your thermostat will provide the home with a source of heat until the compressor is replaced.

Humidifier



In northern climates, outdoor humidity levels are very low when the outside air temperatures are low. Even in well-insulated homes, this dry air makes its way inside through exhaust fans, dryer vents, open doors, and leaks around windows. Problems associated with dry indoor air during heating include:

- Dry nasal passages
- Discomfort at normal room temperatures
- Drying and cracking of woodwork, wood floors, trim, doors
- Damage to wooden musical instruments (e.g. pianos, string instruments, etc.)
- Increased heating costs
- Annoying static shocks

The Desert Spring power humidifier is an excellent solution to avoid these problems. This accessory is easily mounted on the duct work near the unit. Humidity levels are easily controlled with a humidistat.

One of the key benefits to proper humidity levels during heating is improved comfort. Homes that are too dry require that the thermostat be set at a higher setting to maintain a warm feeling. Dry air causes a cooling effect due to the moisture on your skin evaporating. With proper humidity levels, you'll find that you can actually decrease the setting on your thermostat during heating and still have a very comfortable living environment.

Unlike most other whole house humidifiers, the Desert Spring humidifier contains no pads that require cleaning or replacement. Instead, water is distributed over a rotating disk wheel. Air passing through the humidifier picks up the moisture from the disk wheel, and is routed into the home through the duct system providing valuable moisture. Because of the design, all of the water used in the unit is transferred into the home. Other models and styles of humidifiers require a continuous flow of water, of which only a portion is actually absorbed into the air stream and delivered into the home, wasting hundreds of gallons of water throughout the season.

Maintenance

Maintenance is minimal. Unless you have particularly hard water, you will most likely not have to clean the basin or drum during the heating season. For applications with harder water, an automatic flush option is available which automatically purges the basin at regular intervals.

To clean the system (and at the end of the heating season), follow these steps:

- Turn off the humidifier using the humidistat.
- Shut off the water supply to the humidifier.
- Drain the humidifier.
- Open the cover and carefully remove the disk wheel. Wipe down the basin and disk wheel with a vinegar/water solution or a mild household cleaner. Rinse.
- Replace the disk wheel, close the cover and ensure that the drain is closed.

Remember to turn on the water supply and set the humidistat to the required setting at the beginning of the next heating season.

For more information on the Desert Spring humidifier, contact your dealer.

AlpinePure ET (Electronic Air Cleaner)

According to the U.S. Environmental Protection Agency, levels of air pollutants may be two to five times, and in some cases, more than 100 times higher than outdoor air levels. The average cubic foot of indoor air contains 20 million particles, more than 95% of which are smaller than 1 micron (a micron is 1/25,000th of an inch). Most filters simply can't capture these small particles. And to effectively clean the air, submicron particles must be removed.

The AlpinePure ET efficiently captures an unparalleled 97% of these particles down to 0.3 microns. Its superior efficiency is the result of electronic polarization and activated carbon. The filter works by assigning polarity to all the particles in the air as well as to the fiberglass media in the air cleaner. These polarized particles become like small magnets clinging to each other and to the air cleaner media.



The chart below compares a high efficiency media filter efficiency to the AlpinePure ET efficiency with various particle sizes:

CAPTURE EFFICIENCY

PARTICLE SIZE	TYPICAL CONTAMINANT	4-6" PLEATED	DYNAMIC AIR CLEANER
3-10 microns	Pollen, mold, dust, hairspray	98%	99%
1-3 microns	Auto emissions, lead, dust, large bacteria	Not effective	98.6%
0.3 to 1 microns	Tobacco smoke, cooking, smoke, small bacteria, fine dust, paint pigments	Not effective	97%

Unlike typical electronic air cleaners, it does not create ozone or produce any nuisance zapping noises. This air cleaner can be installed easily in your new or existing system without ductwork re-configuration. It is simply installed in the 1-inch filter rack of your geothermal unit.

Cleaning Procedure

The only maintenance that is required is to simply replace the filter media about every 2-4 months. To clean the filter and replace the media, follow these steps:

- Turn off the power to the unit (at the breaker).
- Open the filter access door on the side of the unit.
- On the Powerhead of the air cleaner, unplug the adapter cord. Make sure that the jack does not touch any metallic or grounded surfaces which could result in possible damage to the unit.
- Remove the air cleaner. Brush or vacuum dust and debris from the external wire surface of the air cleaner.
- Carefully open the air cleaner by moving the clips. Remove the old (blue) media pad and discard.
- Position a new pad flat and in the center of the frame.
- Close the air cleaner, and clip shut.
- Plug the adapter cord into the Powerhead of the air cleaner.
- Reinstall the air cleaner into the filter rack. Restore power to the unit.

Note: Because of variations in humidity and temperature, a new media pad may arc or snap slightly when first installed. This is normal and should cease after a few hours of operation. If the arcing persists and/or is rapid, remove and re-position the filter pad. If the arcing continues or if the power indicator light on the Powerhead is dim or out, call your dealer. Only AlpinePure replacement media pads can be used in the AlpinePure ET. Your dealer can supply you with a quantity of replacement media pads.

Keeping your filter clean is one of the most important things you can do to ensure that your geothermal unit operates at its peak efficiency and to minimize the potential for premature failure.

For more information, contact your dealer.



AlpinePure ES (Electrostatic Air Filter)

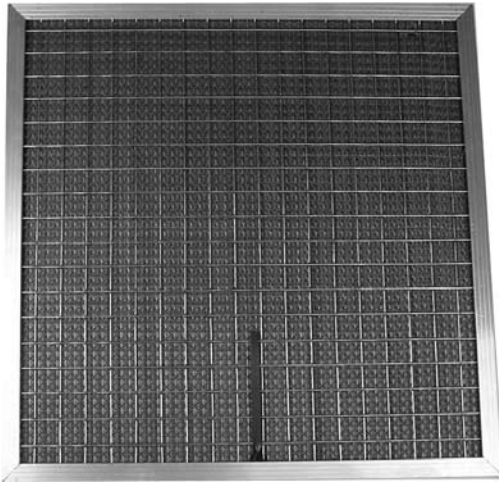

Electrostatic air filters utilize synthetic material which develops an electrostatic charge as friction is applied to the plastic fibers from the movement of air passing through it. The electrostatic charge that is developed as air passes through the filter increase the filter's attraction to particles such as pollen, molds and dust.

An electrostatic filter is generally effective in capturing particles of 1 micron or larger (1 micron is 1/25,000th of an inch). Particles larger than 1 micron include house dust, lint, animal dander, pollen, mold spores and skin flakes. Peak arrestance is 90%, with average arrestance of 89%. The filter contains an anti-microbial media core, three layers of filtration media, a durable aluminum frame, pull tabs and drain holes.

No ductwork modifications are required. This filter is simply used in place of disposable filters located in the return air duct collar on the side of the unit.

Cleaning Procedure

Other than cleaning, the electrostatic filter requires no maintenance. It is recommended that you clean the filter every 30 to 60 days. To clean your electrostatic air filter:

- Turn off the unit at the thermostat, along with the fan if the thermostat is set to constant fan.
- Remove the filter from the filter rack.
- If the buildup is very heavy, you may want to use a vacuum cleaner hose to remove the bulk of the accumulation. This may not be necessary unless the filter is very dirty.
- Spray the filter on both sides with a household cleaning solution (e.g. Fantastic, Formula 409, etc.).
- Lay the filter with the dirty side down, propped at an angle to allow the debris and water to be cleared from the filter.
- Flush the detergent from the filter using a garden hose with a nozzle set at the high pressure setting. In lieu of a garden hose, you can also spray the filter with water from a pressure washer or a sprayer at a "do it yourself" carwash, being careful not to damage the filter material.
- Turn the filter over and rinse again.
- Repeat as necessary to remove all accumulation and until the draining rinse water runs clear.
- Shake excess water out of the filter and allow it to drip dry to the extent that it can be carried without dripping water.
- Insert the filter into the filter rack on the unit, making sure to insert it with the air flow arrow pointing toward the unit.
- Turn the unit back on at the thermostat, along with the fan if you use constant fan operation.

Keeping your filter clean is one of the most important things you can do to ensure that your geothermal unit operates at its peak efficiency and to minimize the potential for premature failure.

Contact your dealer for more information.

AlpinePure HRV



The WaterFurnace AlpinePure HRV (Heat Recovery Ventilator) is a device that moves stale contaminated air from bathrooms and kitchens from inside the home to the outdoors. At the same time it draws fresh, oxygen-rich air from outside, filters it and delivers it throughout your home. Stale, polluted air is constantly being replenished by an equal amount fresh, clean air. As the two air streams pass each other through the HRV they do not mix. However, they do pass on either side of an aluminum heat exchange core that transfers the heat from the air exiting the home to the fresh air coming in. The efficiency (around 83%) is high enough that virtually all of the energy is transferred and little energy is used to condition the incoming fresh air. During cooling the HRV removes the heat from the incoming fresh air and transfers it to the stale exiting air so that the incoming air is “pre-cooled”.

AlpinePure HRVs are designed to be connected to bathroom and kitchen exhaust ducts, replacing the bathroom/kitchen fans.

Independent switches activated in any bathroom turns on the HRV for a 20-minute period. The HRV can also be activated whenever the WaterFurnace unit is heating or cooling, or for continuous operation by activating a separate switch conveniently located in the home. By utilizing the AlpinePure HRV for bathroom ventilation, ordinary noisy exhaust fans are eliminated, and fresh outdoor air is introduced indoors without a major efficiency loss.

With the AlpinePure HRV, the volume of stale discharged air and the amount of incoming fresh air is equal, providing a balanced system. Other ventilation strategies may cause depressurization of the home, causing air infiltration into wall cavities which can lead to moisture damage, rot or harmful mold.

Specifications:

- Delivers 150 or 200 CFM using efficient ECM blower
- Will operate with two on-line fan speeds (4 speeds to choose from)
- Patented all-aluminum heat exchange core is 83% efficient
- Heat exchange core is washable
- Can be installed with up to four switches
- Runs on normal 120 volt household current, less than 50 watts on low speed

Refer to the AlpinePure HRV Owner’s Manual for cleaning instructions of the heat exchange core.

- ① **Automatic Defrost**
Electronic control opens and closes damper to prevent ice build-up.
- ② **Aluminum Heat Exchange Core**
Highly conductive aluminum transfers maximum amount of heat to incoming air. Don’t settle for plastic.
- ③ **Premium Ball Bearing Motor**
Energy efficient and designed for maintenance free life. Quiet and reliable.
- ④ **Easy Clean Filters**
Protect the heat exchange core. Just rinse and replace.
- ⑤ **Fresh outdoor air**
- ⑥ **Fresh conditioned air to home**
- ⑦ **Stale indoor air**
- ⑧ **Stale air to outside**

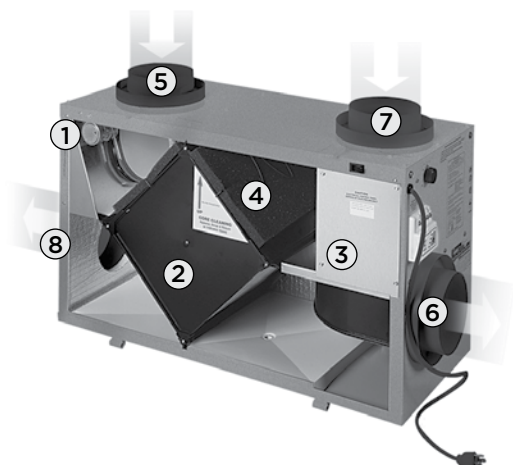

AlpinePure HEPA



For the ultimate in air filtration, the AlpinePure HEPA filter is the best choice. It uses the type of filtration technology required in hospitals and operating rooms. HEPA filters are the most efficient mechanical filters for removing small particles which can be breathed deep into the lungs. The AlpinePure HEPA has a 99.97% efficiency for particle sizes 0.30 microns and larger.

The AlpinePure HEPA incorporates Turbulent Flow Precipitation (TFP) technology. This process involves a principle which illustrates when particle-laden air is forced through a narrow airway, the particles are repeatedly flung against the internal walls. If the walls are smooth, the particles bounce off and re-enter the airstream. The airway walls of the AlpinePure HEPA are made of fabric that traps pollutants as they are flung from the airstream. The result is a high rate of removal of even the smallest debris. Any particles not removed in the TFP process are captured by the primary HEPA filter cartridge.

HEPA filter technology is the most effective way of removing large numbers of the smallest particles. Other less-efficient filtration technologies rate the efficiency in terms of weight, not volume of particles captured. It's easy to understand that larger-sized contaminants (more than 5 microns) weigh more than smaller ones. However, the number of large particles in the air may actually account for less than 1% of the total number of pollutants in the air. The vast majority of the particles in the air are smaller than 5 microns, and these smaller ones can be more detrimental to your health, so it's important to remove those by using devices like the AlpinePure HEPA.

Specifications:

- Efficiency is rated at 99.97% for particles down to 0.30 microns
- Low maintenance—TFP collector is one year replacement, HEPA filter media lasts up to three years
- Foil faced interior cabinet is easily cleaned
- Whisper-quiet operation
- High efficiency fan motor runs on 120 volts, less than 50 watts on low speed

Contact your WaterFurnace Dealer to obtain replacement TFP collectors and HEPA filter media.



- ① **Contaminated Air Supply**
- ② **Flow Through TFP Collector**
One year replacement.
- ③ **Foil Faced Insulated Cabinet**
Easily cleaned and whisper quiet.
- ④ **HEPA Filter**
Lasts up to three years.
- ⑤ **High Efficiency Fan Motor**
- ⑥ **Clean, Filtered Exhaust Air**

AlpinePure 211 & 411 (MERV 11 Filters)



AlpinePure 211 and 411 MERV 11 filters are available in both 2-inch and 4-inch sizes. “MERV” stands for Minimum Efficiency Reporting Value, an industry standard which sets a rated value on the ability of a filter to trap particles ranging in size from 0.3 to 10.0 microns from the air we breathe. Most ordinary, inexpensive filters found at hardware stores are MERV 4 or lower—they are simply ineffective in capturing smaller particles. MERV 11 filters are much more efficient for both small and large particles including pollens, mold spores, dust, fungal spores, and pet dander. In addition, these filters are pleated to increase the surface area, allowing for more holding capacity and less frequent replacement.

Replacement

If you use pleated disposable filters, change them regularly, before they accumulate too much dirt. Do not attempt to clean a disposable filter. Simply throw it away and reinstall a new one. Do not turn a dirty filter over to the clean side and reinstall it—this results in blowing the accumulated dirt right back into the home. AlpinePure 211 and 411 filters can be purchased through your local WaterFurnace dealer.

The suggested replacement interval is 4 to 6 months, depending upon conditions and lifestyle.

Flow Center



A module called the Flow Center circulates the fluid in the closed loop system and through the geothermal unit. This device typically contains one or two small pumps (1/6 hp circulators) that are engaged when the unit is heating or cooling. Generally, one pump is used for units up through 3 tons; two pumps are used for units from 3½ to 6 tons. However, some 4 to 6 ton applications may require only one pump depending on the loop's pressure drop as E Series units have been designed with heat exchangers to operate with single pump flow centers. Systems larger than 6 tons may require a third pump, or the use of a single larger pump, or possibly separate loops and pumps for each unit.

Units using well water do not use a flow center. Rather, they use the well pump.

Maintenance

Flow centers and pumps require no regular maintenance. However, if you experience any of the following, contact your dealer:

- Excessive frost buildup around pump or flow center cabinet.
- Leaking around the fittings.
- Air noise in the water piping.
- A pump that is too hot to touch.
- The unit will not operate without a fault light coming on and stopping operation.



DO NOT ATTEMPT TO SERVICE THE FLOW CENTER. IMPROPER SERVICE COULD RESULT IN ELECTRICAL SHOCK, FLOODING, AIR ENTRAPMENT IN THE LOOP OR EQUIPMENT/SYSTEM FAILURE. CONTACT YOUR DEALER FOR PROPER SERVICE AND REPAIR.

IntelliZone

Now you can precisely control the comfort level of every room in your home with the Premier IntelliZone system. Working with your geothermal unit, electronic thermostat, and multiple motorized zone dampers installed in the duct system, the IntelliZone can eliminate temperature variations that occur throughout your home.

This system allows you to control up to four zones individually. For example, you can heat only the bedrooms at night or cool or heat the downstairs sunroom during the day. Or you can improve comfort to areas that are troublesome. Typical temperature differences are eliminated in two or three story homes, especially with open-entry floor plans.

IntelliZone provides savings by allowing operation in either a “comfort” or “economy” mode for each individual zone. Zones that require less precise temperature control can be set for “economy” mode while zones that require precise control are set for “comfort” mode. Unit staging (sequencing from first to second to third stage operation) is also selectable to best fit the needs of the application.

Zoning is particularly useful where normal heat distribution patterns result in uneven temperature control. For example, a home that is partly below grade can use zoning to eliminate uneven temperature control between the basement and the rest of the home. Large homes that might have long, unequal length duct runs can use zoning to equalize the delivery of conditioned air. Homes with many large windows can use zoning to compensate for solar heat gain and radiation losses at night. Zones can be determined by use, occupancy, location or outside exposure.

Along with providing comfort, zoning can provide energy savings by keeping various zones at desired set points without over-cooling or over-heating other zones. In effect, the IntelliZone conditions only the portions (or zones) which need to be conditioned. This translates into shorter compressor run times and ultimately lower space conditioning bills.

The IntelliZone was designed to solve the typical problems of other ordinary zone control systems. Specifically, the IntelliZone eliminates the need for a bypass damper, works seamlessly with ECM variable speed blowers, uses multiple level zone calls, and is both easy to install and service. Many sizes of motorized dampers are available to meet the needs of a wide variety of applications.

Maintenance

There is no user-maintenance required for the IntelliZone system or the motorized dampers. No lubrication is needed on the damper motors or gears.

For more information on the IntelliZone system, contact your dealer.



Other Accessories

Today's HVAC systems have the ability to incorporate many options and accessories which improve comfort, indoor air quality and add convenience. Of course, not all homeowners select or need the options listed below. However, if you are looking for the ultimate HVAC comfort solution, consider these options and contact your dealer for more information.

Ultraviolet Lights

Special fixtures containing ultraviolet lights can be installed in your system. These lights help to purify the air by killing or sterilizing airborne surface microorganisms including bacteria, germs, mold spores, pollens and some viruses. Although the use of these lights results in cleaner air, they do not physically remove any contaminants-- you'll still need a filter. Ultraviolet lights have been used for many years in hospitals to help clean the air and reduce the spread of germs. In addition to the health benefits offered with this technology, equipment efficiency can be improved by the fact that the air coil is kept cleaner. These components consume about as much energy as a 75 watt light bulb. The bulbs last for about a year and are easy to change.

Note: The use of ultraviolet lights with a WaterFurnace unit can be harmful to the protective coating on the air coil, the drain pan and wiring, and therefore is not recommended and may void your warranty.

Remote Access Controllers

With continually advancing communication technologies, some manufacturers are now offering the ability to access or monitor your HVAC system from a remote location using devices known as Remote Access Controllers. There are two main benefits to this technology. These systems have the ability to automatically call a designated number (or your HVAC contractor) if the unit malfunctions. The other benefit is the ability to adjust your temperature settings over the phone. This is particularly beneficial for vacation homes. Remote access controllers require a phone line connection.

WATERFURNACE MERCHANDISE

Now that you're the proud owner of the best heating and cooling system available, show your pride by wearing some of our quality promotional merchandise. We've got a great variety of name-brand shirts, jackets, caps and other items with the WaterFurnace logo.

To view our complete product selection, go to www.waterfurnace.com and click on the merchandise link. All products can be ordered on-line. It's easy and convenient. Orders are shipped directly to your location.

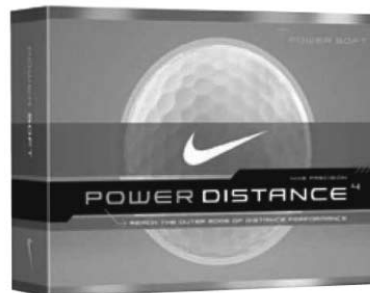

GLOSSARY

Learn how to talk just like your favorite HVAC contractor using these key terms.

AFUE (Annual Fuel Utilization Efficiency): The percent (efficiency) of fossil fuel furnaces. Includes cycling and flue losses and other factors.

BTU (British Thermal Unit): The amount of heat needed to raise the temperature of one pound of water one degree Fahrenheit.

BTUH: The number of BTUs produced in one hour; used to signify the heating and cooling capacity of a system and the heat losses and gains of buildings and homes.

CFM (Cubic Feet per Minute): Volume of air movement. Used in duct design calculations.

Compressor: The central part of a heat pump system. The compressor increases the pressure and temperature of the refrigerant and simultaneously reduces its volume while causing the refrigerant to move through the system.

Condenser: A heat exchanger in which hot, pressurized (gaseous) refrigerant is condensed by transferring heat to cooler surrounding air, water or earth.

COP (Coefficient of Performance): Heating efficiency rating for a geothermal system. BTU output divided by BTU input.

Degree Days (Heating & Cooling): Calculated by adding the high and low temperatures of the day, dividing by 2, then subtracting from 65. (Example: High 42, Low 20 = 34 heating degree days.)

Delta T (or ΔT): The change in temperature (degrees). Usually associated with water or air temperatures.

Desuperheater: A device that recovers superheat from the compressor discharge gas for heating water.

EER (Energy Efficiency Ratio): Cooling efficiency rating for geothermal systems. BTU output divided by Watt input.

Fossil fuel: Any of several types of combustible fuels formed from the decomposition of organic matter. Examples are natural gas, propane, fuel oil, oil and coal.

GPM (Gallons per Minute): A reference to the flow rate of water through the geothermal unit.

Heat Exchanger: A device designed to transfer heat between two physically separated fluids or mediums (air, water, or refrigerant) of different temperatures.

Heat Loss: The amount of energy (BTUs/hr) lost from the home during cold weather that needs to be overcome/supplied by the heating system. The amount varies based on outdoor air temperatures.

Heat Gain: The amount of heat (BTUs/hr) that is absorbed by the home during hot weather, requiring removal by the air conditioner in order to cool the home. Varies based on outdoor air temperatures.

Heat Sink: The medium (air, water or earth) which receives heat rejected from a heat pump.

Heat Source: The medium (air, water or earth) from which heat is extracted by a heat pump.

HSPF (Heating Season Performance Factor): Heating efficiency rating for heat pumps over the course of the entire heating season.

Infiltration / Exfiltration: Air movement into the home through "leaks" (infiltration); or movement of air from inside the home to the outside (exfiltration).

Relative Humidity: The ratio of the amount of water vapor actually present in the air to the greatest amount possible at the same temperature. During heating, RH levels of 40-50% are generally recommended.

R-Value: The resistance of heat movement through an insulating material. Varies with thickness and type.

SEER (Seasonal Energy Efficiency Ratio): Cooling efficiency rating for heat pumps and air conditioners. Calculated over the entire cooling season.

Solar Gains: Heat gain generated through the heating of walls and windows by the sun.

Ton: In HVAC terms, 12,000 BTUs per hour.

Wind Chill: A still-air temperature that would have the same cooling effect on exposed skin as a given combination of temperature and wind speed. Does not affect heating requirements for your home.

ADDITIONAL NOTES:

PREVENTIVE MAINTENANCE SERVICE RECORD

In order to keep your system operating at peak performance levels, WaterFurnace recommends that you take advantage of your dealer's planned maintenance program. This will normally include semi-annual preventive maintenance checks.

YEAR	DATE OF 1st SERVICE CHECK	DATE OF 2nd SERVICE CHECK	NOTES
2008			
2009			
2010			
2011			
2012			
2013			
2014			
2015			
2016			
2017			
2018			
2019			
2020			
2021			
2022			
2023			
2024			
2025			
2026			
2027			
2028			
2029			
2030			
2031			
2032			



WFOM 10/08